



Advanced Computer Systems



Instrument Processing Facility L2

Doc. No.: *CS-RS-ACS-GS-5123*
Issue: *2.1*
Date: *18 February 2008*
Page: *1*

CRYOSAT Ground Segment

Instrument Processing Facility L2

L2 Products Format Specification

[L2-FMT]

CS-RS-ACS-GS-5123

Issue: 2.1

Date: 18/02/2008

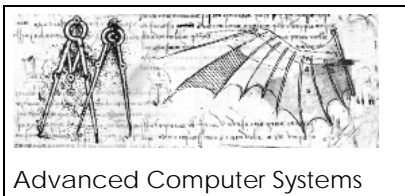

Document Signature Table

APPROVAL TABLE		
Date		
Name	Function	Signature
P.L. MANTOVANI	ACS Project Manager	
P. FEMENIAS	ESA Project Manager	
P. GILLES	Cryosat PDGS Manager	

CONTRACTOR TABLE				
	Name	Function	Signature	Date
Author	ACS Team MSSL Team			
Verification	PL MANTOVANI S. BAKER	IPF2 Project Manager MSSL Team Responsible		
Quality Assurance	A. GIUSTINIANI	Quality Manager		
Approval	P.L. MANTOVANI	IPF2 Project Manager		

Distribution List

Internal Distribution	
Name	No. Copies
N. Vacca	1
T. Geminale	1
M. Antonacci	1
M. Epifani	1
P. Mantovani	1
V. Spaventa	1
A. Vollono	1
R. Medri	1

External Distribution		
Company	Name	No. Copies
ESA	P. Femenias	1
MSSL	S. Baker	1



Advanced Computer Systems



Instrument Processing Facility L2

Doc. No.: CS-RS-ACS-GS-5123
 Issue: 2.1
 Date: 18 February 2008
 Page: 3

Document Change Record

Issue/Rev.	Class (R=Review /A=Approval)	Date	Reason for Change	Changed Pages/Paragraphs
Cryosat 1				
1.0	R	31/01/2004	Initial Issue for IPF2 Vb	all
1.1	R	26/11/2004	Updated Issue for IPF2 Vd	See sidebars
1.2 Draft	A	16/05/2005	XML and ASCII SPH updated: Surface Id statistics fields introduced List of DS_NAME for Measurement DSD updated to account for Fast Delivery Ocean Processing Chain and the introduction of the old-fashioned products (intermediate).	
1.3	A	16/06/2005	Final Issue for Ve release (excluding FDM chain)	Section 2.3.3 Completely updated
1.4	A	02/08/2005	Inclusion of Fields descriptions + typo Corrections + inclusion of FDO format	
1.5	A	05/09/2005	L2 Product fields 22 and 23 changed from us to ss format	Section 2.3.3.1
1.6	A	09/09/2005	Typographical Corrections	See Sidebars
1.7	A	24/06/2006	Inclusion of new DS Name for new geocorrections files	See Sidebars
Cryosat 2				
2.0	R	28/01/2008	Vh 1.0 delivery (SIRAL redundancy)	The following sections have been changed: 2.2.2.2 / 2.3.2 / 2.3.3.1 / 2.3.3.2 / 4
2.1	R	18/02/2008	Inserted Comments received during Vh1.0 QR	The following sections have been changed: = Approval Table = Section 1.3.2 (Reference Documents) = Section 2.3.1 (Table 2.3.1-1, reference to LTA added) = Section 2.3.2 (Table 2.3.2-5 reference to CAL3 removed)

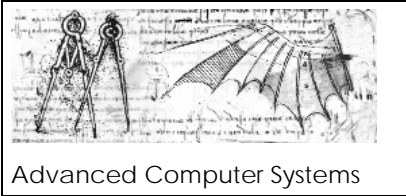

Instrument Processing Facility L2

Doc. No.: CS-RS-ACS-GS-5123
Issue: 2.1
Date: 18 February 2008
Page: 4

				= Section 2.3.3.2 (Table 2.3.3.2-4 (MCD Falgs updated)) = Section 2.3.3.2 (Table 2.3.3.2-2 Reference to CAL3 removed)
--	--	--	--	--

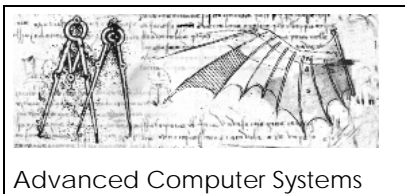

TABLE OF CONTENTS

1	INTRODUCTION	6
1.1	PURPOSE AND SCOPE	6
1.2	DOCUMENT STRUCTURE.....	6
1.3	APPLICABLE & REFERENCE DOCUMENTS	7
1.3.1	<i>Applicable Documents.....</i>	<i>7</i>
1.3.2	<i>Reference Documents.....</i>	<i>7</i>
1.4	ACRONYMS AND ABBREVIATIONS	8
2	LEVEL-2 GENERAL FORMAT DESCRIPTION	9
2.1	FILE STRUCTURE	12
2.2	XML HEADER FILE	13
2.2.1	<i>Fixed Header (Cryosat Header).....</i>	<i>13</i>
2.2.2	<i>Variable Header (Product Header).....</i>	<i>14</i>
2.2.2.1	XML Main Product Header (XML MPH)	14
2.2.2.2	XML Specific Product Header (XML SPH).....	17
2.3	PRODUCT FILES.....	23
2.3.1	<i>Main Product Header (MPH)</i>	<i>24</i>
2.3.2	<i>Specific Product Header (SPH).....</i>	<i>31</i>
2.3.3	<i>Measurement Data Set Record (MDS).....</i>	<i>42</i>
2.3.3.1	L2 MDS Records Layout.....	43
2.3.3.2	Intermediate L2 MDS Records Layout.....	51
3	FAST DELIVERY OCEAN L2 DATA PRODUCTS	73
4	CRYOSAT LEVEL-2 PRODUCTS NAMING	81



Advanced Computer Systems



Instrument Processing Facility L2

Doc. No.: *CS-RS-ACS-GS-5123*
Issue: *2.1*
Date: *18 February 2008*
Page: *6*

1 INTRODUCTION

This document contains the description of the format of the Level-2 products generated inside the PDS for the Cryosat mission.

1.1 PURPOSE AND SCOPE

The purpose of the document is to define the product structure and the content of the Level-2 file generated in the PDS identifying for each data section and field the meaning and the format to be used for its representation.

1.2 DOCUMENT STRUCTURE

The document includes the following sections:

Section 1 - Introduction

The present section.

Section 2 - Level-2 General Format Description

This section gives the general description of the Level-2 products in terms of common organisation and format and the detailed description of the format for each file type.

Section 3 - Cryosat Level-2 Products

This section contains the product file name and the composition rules of the file name.



Advanced Computer Systems



Instrument Processing Facility L2

Doc. No.: CS-RS-ACS-GS-5123
Issue: 2.1
Date: 18 February 2008
Page: 7

1.3 APPLICABLE & REFERENCE DOCUMENTS

1.3.1 Applicable Documents

Document Title	Identifier	Reference
Earth Explorer Ground Segment File Format Standard Issue 1.4 , 13 June 2003	PE-TN-ESA-GS-0001	[FMT-GUIDE]
Cryosat Ground Segment Master ICD Issue 4.2, 18 October 2007	CS-ID-ESA-GS-0147	[MASTER-ICD]

1.3.2 Reference Documents

Document Title	Identifier	Reference
IPF2 Processors Architecture Description Issue 1.0, 20 November 2003	CS-TN-ACS-GS-5120	[IPF2-TN]
IPF1 Product Formats Specification Issue 4.0, 10 December 2007	CS-RS-ACS-GS-5106	[L1-FMT]
Level 0 Products Specification Format Issue 3.1, 06 November 2007	CS-ID-ACS-GS-0119	[L0-FMT]
IEEE Standard for Binary Floating-Point Arithmetic. ANSI/IEEE Std 754-1985 Institute of Electrical and Electronics Engineers Issued 1985	IEEE-754	[IEEE]
Extensible Markup Language (XML) 1.0 (Second Edition) W3C Recommendation 6 October 2000	http://www.w3.org/TR/2000/REC-xml-20001006	[XML-GUIDE]
XML Schema Definition Language: W3C XML Schema Working Group and Schema Specifications	http://www.oasis-open.org/cover/schemas.html#W3CWorkingGroup	[XML-SCHEMA]

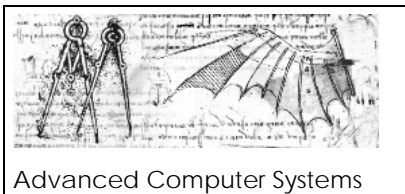

Advanced Computer Systems



Instrument Processing Facility L2

Doc. No.: *CS-RS-ACS-GS-5123*
Issue: *2.1*
Date: *18 February 2008*
Page: *8*

1.4 ACRONYMS AND ABBREVIATIONS

ACS	Advanced Computer Systems S.p.A.
AGC	Automatic Gain Control
AIR	Azimuth Impulse Response
AISP	Annotated Instrument Source Packet
APID	Application Process IDentifier
BER	Bit Error Rate
BLOB	Binary Large OBject
CADU	Channel Access Data Unit
CAL	Calibration
CCSDS	Consultative Committee for Space Data Systems
CVCDU	Coded Virtual Channel Data Unit
DSR	Data Set Record
EO	Earth Observation
ESA	European Space Agency
FOS	Flight Operations Segment
FBR	Full Bit Rate
FDO	Fast delivery Ocean
G/S	Ground Segment
HK/TM	Housekeeping/Telemetry data
ID	IDentifier
I/O	Input/Output
ISP	Instrument Source Packet
L1B	Level 1B
LRM	Low Rate Mode
MDS	Measurement Data Set
MJD	Modified Julian Day
MON	Monitoring
MPH	Main Product Header
PDS	Payload Data Segment
PSLR	Peak to Side Lobe Ratio
PSS-05	ESA Software Engineering Standard
rc	Radar Cycle
RIR	Range Impulse Response
SIRAL	Synthetic Interferometric Radar ALtimeter
SOW	Statement Of Work
SPH	Specific Product Header
TAI	International Atomic Time Reference
TBC	To Be Clarified
TBD	To Be Defined
TT&C	Tracking, Telemetry and Command
UTC	Universal Time Co-ordinates
VCID	Virtual Channel IDentifier
VCDU	Virtual Channel Data Unit
WGS84	World Geodetic System 1984
XML	eXtensible Markup Language



Advanced Computer Systems



Instrument Processing Facility L2

Doc. No.: *CS-RS-ACS-GS-5123*
Issue: *2.1*
Date: *18 February 2008*
Page: *9*

2 LEVEL-2 GENERAL FORMAT DESCRIPTION

The Level-2 products are derived from the Cryosat L1B products generated by the IPF1 and relevant to the science modes, that is LRM – SAR – SARIN (nominal and degraded).

Differently from the L1B products, a common layout (i.e. independent of the SIRAL operative mode) is defined for the Level 2 products.

A L2 product is generated soon after a L1B product is available thus resembling still a data driven approach. This implies that following this first generation step there will be L2 products still separated by modes (specifically LRM – SAR – SARin) defined over the same time window of the input L1B.

The L2 data is the main output from the L2 processors. This is a compact Geophysical Data Record designed to minimise the volume of data distributed to Users. However, a second L2 data set can be output which is called 'Intermediate L2' and is identified with an 'I' in the filetype: SIR_XXXI2X. This dataset contains many more parameters and flags and is consequentially much larger. The intermediate format is in any case required as the input to the second pass of the L2 SAR processing for Sea Ice areas.

In the second step of the processing, a global L2 product is generated from the L2 mode dependent products collected over an entire orbit, specifically from ANX to ANX. This second step most likely does not imply any specific processing, but simply a concatenation of files in chronological order. L2 products from the first step, in fact, regardless of their SIRAL mode dependence, have binary records with the same layout.

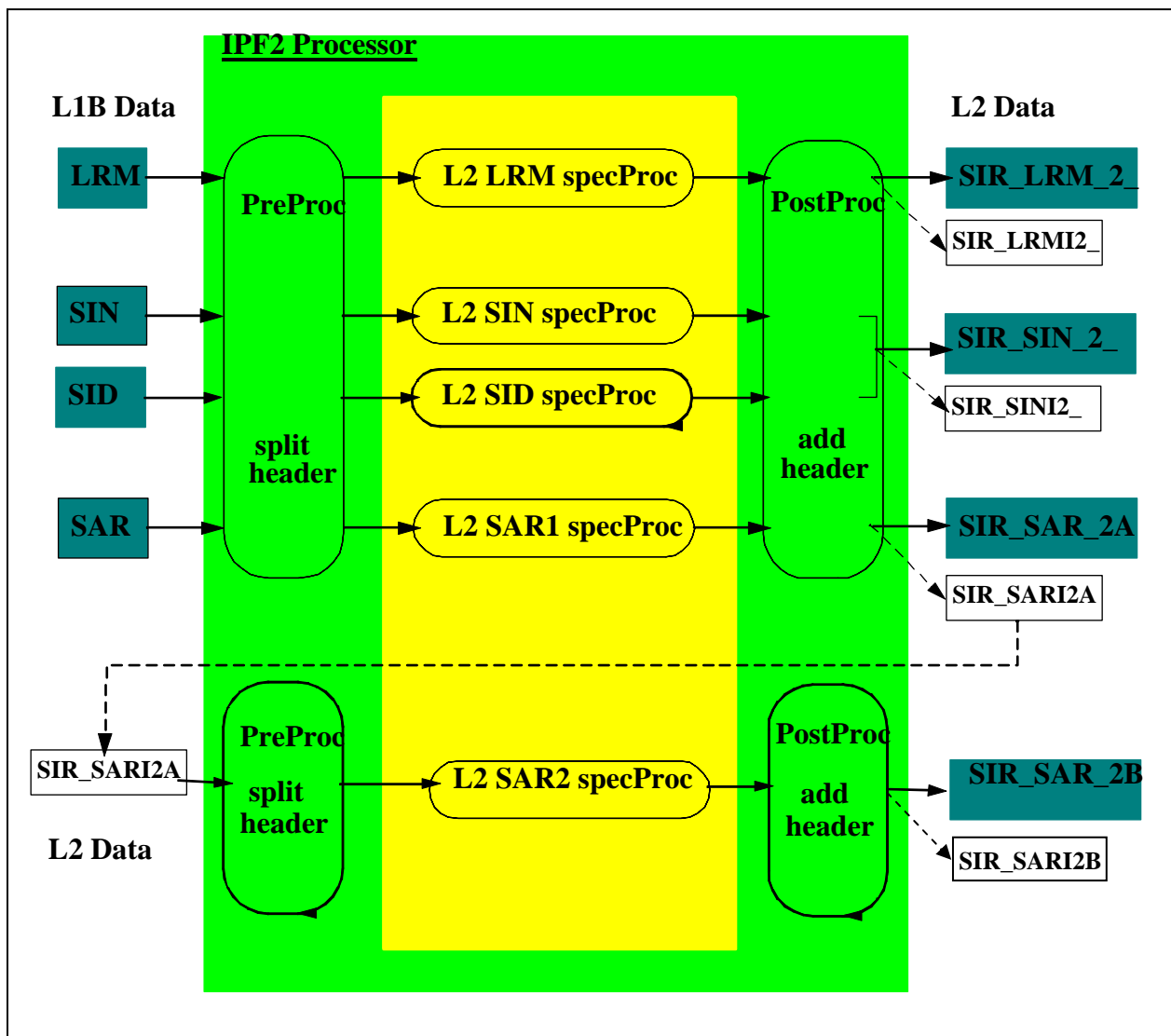

Figure 2-1 Level 2 (Step 1) Product Generation

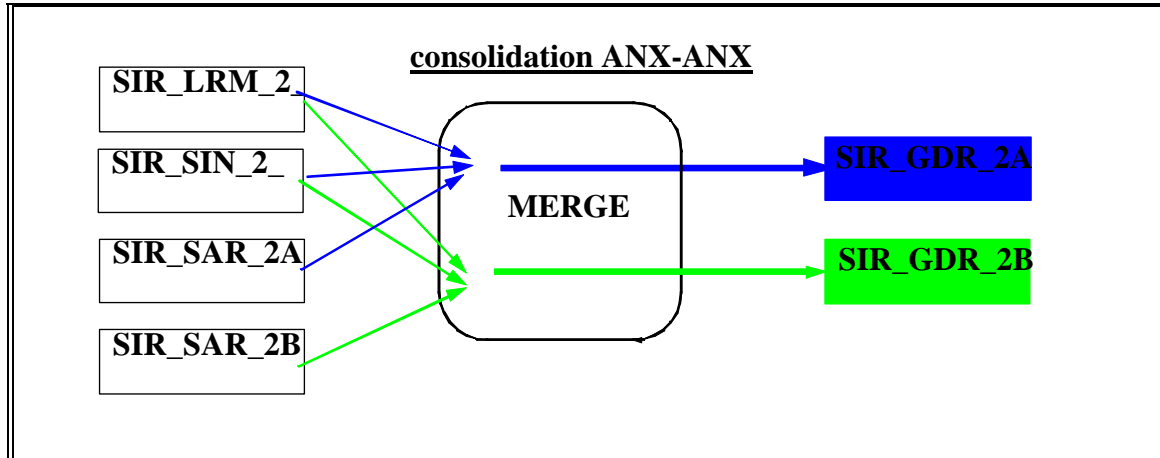

Figure 2-2 Level 2 (Step 2) Anx to Anx Consolidation

2.1 FILE STRUCTURE

The file structure of any file produced by the IPF2 system must follow the requirements of the [FMT-GUIDE] .

Each level-2 product is composed by two files:

- XML Header File
- Product File

The XML Header file is an auxiliary ASCII file that users can easily access for identifying the product without needs to look inside the Product File.

The Product File is the real product containing meaningful instrument’s data and ASCII header used by ad hoc developed standard tools for inspecting the product’s content. In order to use tools already developed for the ENVISAT mission, the product structure for Cryosat will follow the correspondent one of the ENVISAT products as far as possible.

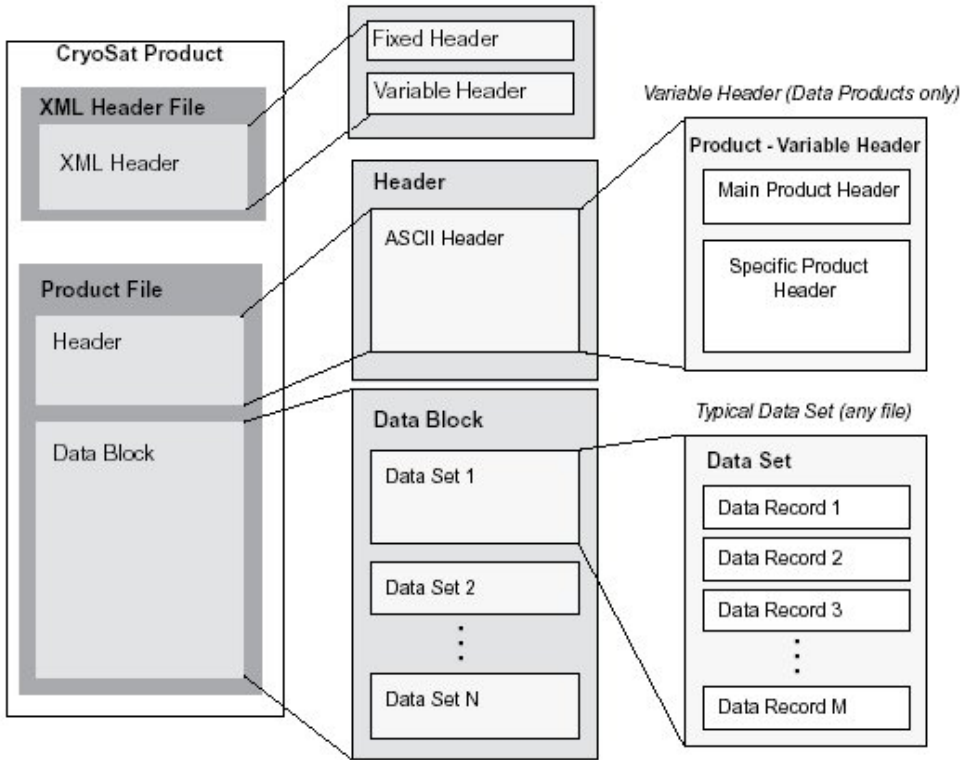



Advanced Computer Systems



Instrument Processing Facility L2

Doc. No.: *CS-RS-ACS-GS-5123*
Issue: *2.1*
Date: *18 February 2008*
Page: *13*

2.2 XML HEADER FILE

The XML Header file contains information identifying the product and easy to read as based on a standard syntax accessed by common tools available for visualising its content. The XML syntax has been chosen for the scope of the PDS.

The XML Header file is composed by:

- a Fixed Header
- a Variable Header

The Fixed Header (hereafter called Standard Cryosat Header) is the common header for all files managed into the PDS. That means it is applied to all files flowing amongst the sub-systems composing the PDS.

The Variable Header (hereafter called Product Header) is the header with format and content depending on the file type and kind of product.

2.2.1 Fixed Header (Cryosat Header)

The Standard Cryosat Header is completely ASCII and based on XML syntax and conventions proposed in [FMT-GUIDE].

The format and content of the Standard Cryosat Header is under ESA responsibility and it is specified in [FMT-GUIDE].

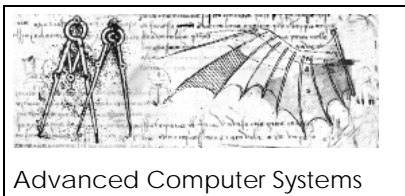

2.2.2 Variable Header (Product Header)

The Variable Header (hereafter called Product Header) for the Level 1 product is composed by:

- a XML Main Product Header (XML MPH)
- a XML Specific Product Header (XML SPH) which includes Reference Data Set Descriptors for external input files one or more XML Specific Measurement Data Header (XML MDH) for the Data Sets of the Product

The XML MPH and XML SPH are derived from the correspondent headers (MPH and SPH) of the Product File, removing the unused fields and fields already reported in the Standard Cryosat Header.

Each header is completely ASCII and based on XML syntax and conventions proposed in the [FMT-GUIDE].

The following paragraphs describe the format and content of the XML MPH and XML SPH without overload of the XML format description.

2.2.2.1 XML Main Product Header (XML MPH)

Field #	Description	Units	Bytes	Format
	MPH	Tag		
	<i>Product Identification Info</i>			
#01	Product	Tag		
	Product File Name Note: the file name shall be without extension		62	See Section 3
#02	Proc_Stage_Code	Tag		
	Processing stage code identifier: RPR0 = Reprocessing OFFL = Routine Operations NRT_ = Near Real Time TEST = Test LTA_ = Long Term Archive		4	4*uc
#03	Ref_Doc	Tag		
	Reference DFCB Document describing the product		23	CS-RS-ACS-GS-5106
	<i>Data Processing Information</i>			



Advanced Computer Systems



Instrument Processing Facility L2

Doc. No.: CS-RS-ACS-GS-5123
 Issue: 2.1
 Date: 18 February 2008
 Page: 15

#04	Proc_Time	Tag		
	Processing Time (Product Generation Time)		30	UTC=yyyy-mm-ddThh:mm:ss.uuuuuu
#05	Software_Version	Tag		
	Processor Name and software version number.		14	ProcessorName/VV.rr
<i>Orbit Information</i>				
#06	Phase	Tag		
	Phase Code: If not used set to X		1	uc
#07	Cycle	Tag		
	Cycle number. If not used set to +000		4	%+04d
#08	Rel_Orbit	Tag		
	Relative Orbit Number at sensing start time. If not used set to +00000		6	%+06d
#09	Abs_Orbit	Tag		
	Absolute Orbit Number at sensing start time. If not used set to +00000		6	%+06d
#10	State_Vector_Time	Tag		
	UTC state vector time		30	UTC=yyyy-mm-ddThh:mm:ss.uuuuuu
#11	Delta_UT1	Tag		
	Universal Time Correction: DUT1 = UT1 – UTC If not used set to +.000000	s	8	%+08.6f
#12	X_Position	Tag		
	X position in Earth Fixed Reference If not used set to +0000000.000	m	12	%+012.3f
#13	Y_Position	Tag		
	Y position in Earth Fixed Reference If not used set to +0000000.000	m	12	%+012.3f
#14	Z_Position	Tag		
	Z position in Earth Fixed Reference If not used set to +0000000.000	m	12	%+012.3f
#15	X_Velocity	Tag		
	X velocity in Earth Fixed Reference If not used set to +0000.000000	m/s	12	%+012.6f
#16	Y_Velocity	Tag		
	Y velocity in Earth Fixed Reference	m/s	12	%+012.6f

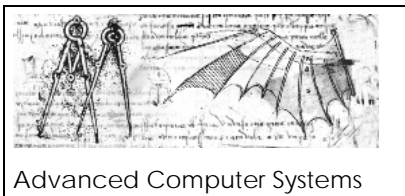

	If not used set to +0000.000000			
#17	Z_Velocity	Tag		
	Z velocity in Earth Fixed Reference If not used set to +0000.000000	m/s	12	%+012.6f
#18	State_Vector_Source	Tag		
	Source of Orbit State Vector Record FP = FOS predicted DN = DORIS Level 0 navigator DP = DORIS precise orbit FR= FOS Restituted DI = DORIS Preliminary		2	2*uc
<i>Product Confidence Data Information</i>				
#19	Product_Err	Tag		
	Product Error Flag 1 errors have been reported in the Product 0 no errors		1	uc
<i>Product Size Information</i>				
#20	Tot_Size	Tag		
	Total Size of the Data Product	bytes	21	%021d

Table 2.2.2.1-1: XML Main Product Header Description

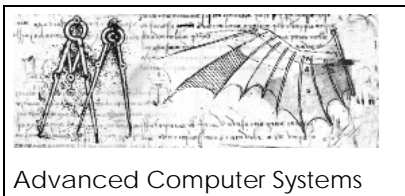

2.2.2.2 XML Specific Product Header (XML SPH)

Field #	Description	Units	Bytes	FORMAT
	SPH	tag		
<i>Product description and identification</i>				
#1	SPH_Descriptor	tag		
	Name describing the Specific Product Header		28	<i>ProductID SPECIFIC HEADER See Table 3-1</i>
<i>Product Time information</i>				
	Time_Information	tag		
#2	Start_Record_Time	tag		
	TAI of the first record in the Main MDS of this product		30	TAI=yyyy-mm-ddThh:mm:ss.uuuuuu
#3	Stop_Record_Time	tag		
	TAI of the last record in in the Main MDS of this product		30	TAI=yyyy-mm-ddThh:mm:ss.uuuuuu
<i>Product Orbit information</i>				
	Orbit_Information	Tag		
#4	ABS_Orbit_Start	Tag		
	Absolute Orbit Number at sensing start time.		6	%06d
#5	Rel_Time_ASC_Node_Start	Tag		
	Relative time since crossing ascending node time relative to start time of data sensing.	s	11	%011.6f
#6	ABS_Orbit_Stop	Tag		
	Absolute Orbit Number at sensing stop time.		6	%06d



Advanced Computer Systems



Instrument Processing Facility L2

Doc. No.: CS-RS-ACS-GS-5123
 Issue: 2.1
 Date: 18 February 2008
 Page: 18

#7	Rel_Time_ASC_Node_Stop	Tag		
	Time of the ascending node relative to stop time of data sensing. Relative time since crossing ascending node time relative to stop time of data sensing.	s	11	%011.6f
#8	Equator_Cross_Time	Tag		
	Time of equator crossing at the ascending node relative to the sensing start time.		30	UTC=yyyy-mm-ddThh:mm:ss.uuuuuu
#9	Equator_Cross_Long	Tag		
	Longitude of equator crossing at the ascending node relative to the sensing start time (positive East, 0 = Greenwich) referred to WGS84.	10-6 deg	11	%+011d
#10	Ascending_Flag	Tag		
	Orbit Orientation at the sensing start time A=Ascending D=Descending		1	uc
<i>Product Location Information</i>				
	Product_Location	tag		
#11	Start_Lat	tag		
	WGS84 latitude of the first record in the Main MDS (positive north)	10-6 deg	11	%+011d
#12	Start_Long	tag		
	WGS84 longitude of the first record in the Main MDS (positive East, 0 = Greenwich)	10-6 deg	11	%+011d
#13	Stop_Lat	tag		
	WGS84 latitude of the last record in the Main MDS (positive north)	10-6 deg	11	%+011d



Advanced Computer Systems



Instrument Processing Facility L2

Doc. No.: CS-RS-ACS-GS-5123
 Issue: 2.1
 Date: 18 February 2008
 Page: 19

#14	Stop_Long	tag		
	WGS84 longitude of the last record in the Main MDS (positive East, 0 = Greenwich)	10-6 deg	11	%+011d
<i>SIRAL Level 1B Quality information</i>				
	Level_1_Confidence_Data	tag		
#15	L1_Proc_Flag	tag		
	Processing errors significance flag			
	1 errors (percentage of errors greater than threshold)		1	uc
	0 no errors			
#16	L1_Processing_Quality	tag		
	Percentage of quality checks successfully passed during the SP processing (max allowed +10000)	10-2 %	6	%+06d
#17	L1_Proc_Thresh	tag		
	Minimum acceptable percentage of quality threshold that must be passed during SP processing (max allowed +10000)	10-2 %	6	%+06d
#18	Num_L1_DSR_Processed	tag		
	Number of L1 Data Set Records analysed		11	%+011d
<i>SIRAL Instrument Configuration</i>				
	SIR_Instrument_Configuration	tag		
#19	Instrument_Identifier	tag	1	1*uc A (SIRAL Nominal) B (SIRAL Redundant)
<i>SIRAL Mode Statistics</i>				
	SIR_Mode_Statistics	tag		
#20	LRM_Mode_Percent	tag		
	Percentage of input Level 1B records detected in LRM mode	10-2 %	6	%+06d
#21	SAR_Mode_Percent	tag		



Advanced Computer Systems



Instrument Processing Facility L2

Doc. No.: CS-RS-ACS-GS-5123
 Issue: 2.1
 Date: 18 February 2008
 Page: 20

	Percentage of input Level 1B records detected in SAR mode	10-2 %	6	%+06d
#22	SARIN_Mode_Percent	tag		
	Percentage of input Level 1B records detected in SARIN mode	10-2 %	6	%+06d
#23	Other_Modes_Percent	tag		
	Percentage of input Level 1B records detected in other modes	10-2 %	6	%+06d
<i>SIRAL L1B Surface Statistics</i>				
	Surface_Statistics	tag		
#24	Open_Ocean_Percent	tag		
	Percentage of records detected on open ocean or semi-enclosed seas	10-2 %	6	%+06d
#25	Close_Sea_Percent	tag		
	Percentage of records detected on close seas or lakes	10-2 %	6	%+06d
#26	Continent_Ice_Percent	tag		
	Percentage of records detected on continental ice	10-2 %	6	%+06d
#27	Land_Percent	tag		
	Percentage of records detected on land	10-2 %	6	%+06d
<i>SIRAL Level 2 Processing information</i>				
	Level_2_Confidence_Data	tag		
#28	L2_Prod_Status	tag		
	Complete/Incomplete Product Completion Flag (0 or 1). 1 if the Product as a duration shorter than the input Level 0		1	uc
#29	L2_Proc_Flag	tag		
	Processing errors significance flag 1 errors (percentage of errors greater than threshold) 0 no errors		1	uc



#30	L2_Processing_Quality	tag		
	Percentage of quality checks successfully passed during Level 1B processing (max allowed +10000)	10-2 %	6	%+06d
#31	L2_Proc_Thresh	tag		
	Minimum acceptable percentage of quality threshold that must be passed during Level 1B processing (max allowed +10000)	10-2 %	6	%+06d
<i>Data Set Descriptors</i>				
	DSDs	tag		
	List_of_DSDs	tag		
	Data_Set_Descriptor	tag		
#32	Data_Set_Name	tag		
	Name of the Data Set		28	uc
#33	Data_Set_Type	tag		
	M for Measurement – R for Reference		1	uc
#34	File_Name	tag		
	Name of the reference file. Field is left empty for Measurement DSD		62	uc
#35	Data_Set_Offset	tag		
	Offset in bytes from the beginning of the DBL file. For reference DSDs the field is set to 0.	bytes	21	%+021d
#36	Data_Set_Size	tag		
	Size in bytes of the Measurement Data Set Record. For reference DSDs the field is set to 0.	bytes	21	%+021d
#37	Num_of_Records	tag		
	Number of Data Set Records. For reference DSDs the field is set to 0.		11	%+011d
#38	Record_Size	tag		
	Record size in bytes. For reference DSDs the field is set to 0.	bytes	11	%+011d
#39	Byte_Order	tag		

<p>It describes the endianness of the data set 3210 → Big-endian 0123 → Little-endian</p> <p>For Reference DSDs the field is left empty</p>		4	<p>%4c</p> <p>3210 for Cryosat</p>
---	--	---	------------------------------------

Table 2.2.2.2-1: XML Specific Product Header description

2.3 PRODUCT FILES

The Product File structure will follow the one defined for the ENVISAT level-0 products as much as possible.

As shown in figure 2.3-1, each product file is composed by:

- Main Product Header (MPH)
- Specific Product Header (SPH)
- Data Sets

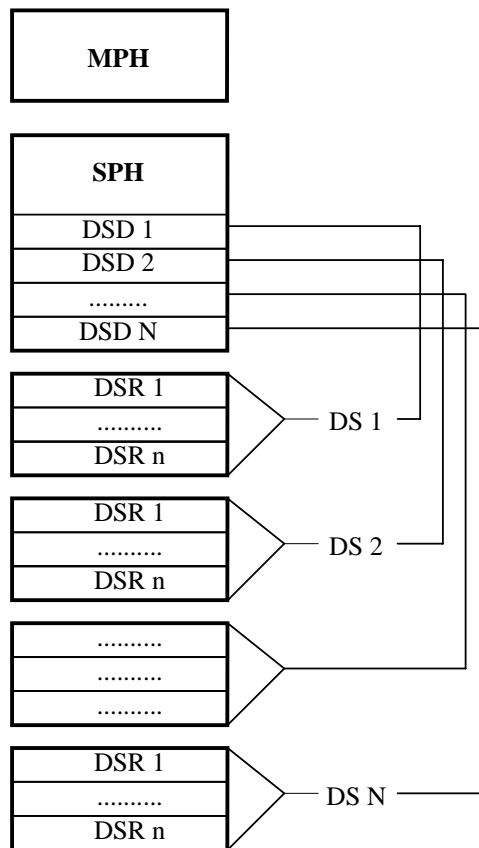

Figure 2.3-1: Generalised Product Structure

The MPH and SPH blocks are ASCII and following the current syntax for any composing field:

FieldName= value<units>

The Data Sets are completely binary and contains one or more Data Set Records each. According to the following Products definitions the maximum number of DS in a product is two.



Advanced Computer Systems



Instrument Processing Facility L2

Doc. No.: CS-RS-ACS-GS-5123
 Issue: 2.1
 Date: 18 February 2008
 Page: 24

2.3.1 Main Product Header (MPH)

Field #	Description	Units	Bytes	Format
<i>Product Identification Info</i>				
#01	PRODUCT=	keyword	8	
	quotation mark (")		1	uc
	Product File Name It is left justified with trailer blanks		62	See 3.1
	quotation mark (")		1	uc
	newline character	terminator	1	
#02	PROC_STAGE=	keyword	11	11*uc
	Processing stage code: N = Near-Real Time T = Test O = OFF Line (Systematic) R = Reprocessing L = Long Term Archive		1	
	newline character	terminator	1	
#03	REF_DOC=	keyword	8	8*uc
	quotation mark (")		1	uc
	Reference DFCB Document describing the product		23	23*uc
	quotation mark (")		1	uc
	newline character	terminator	1	
#04	Spare (blank characters)		40	40*uc
	newline character	terminator	1	uc
<i>Data Processing Information</i>				
#05	ACQUISITION_STATION=	keyword	20	20*uc
	quotation mark (")		1	uc
	Acquisition Station ID Filled by blanks		20	Kiruna
	quotation mark (")		1	uc
	newline character	terminator	1	
#06	PROC_CENTER=	keyword	12	12*uc
	quotation mark (")		1	uc
	Processing Center ID code		6	Either PDS or LTA
	quotation mark (")		1	uc
	newline character	terminator	1	



Advanced Computer Systems



Instrument Processing Facility L2

Doc. No.: CS-RS-ACS-GS-5123
 Issue: 2.1
 Date: 18 February 2008
 Page: 25

#07	PROC_TIME=	keyword	10	10*uc
	quotation mark (")		1	uc
	Processing Time (Product Generation Time)	UTC	27	dd-MMM-yyyy hh:mm:ss.uuuuuu
	quotation mark (")		1	uc
	newline character	terminator	1	
#08	SOFTWARE_VER=	keyword	13	13*uc
	quotation mark (")		1	uc
	Processor name, up to 8 characters, and software version number followed by trailer blanks if any. If not used set to blanks		14	14*uc ProcessorName/VV.rr
	quotation mark (")		1	uc
	newline character	terminator	1	
#09	Spare (blank characters)		40	40*uc
	newline character	terminator	1	uc
<i>Information on Time of Data</i>				
#10	SENSING_START=	keyword	14	14*uc
	quotation mark (")		1	uc
	UTC start time of data sensing. This is the UTC start time of the Input Level 1B/L2 Product. If not used set to 27 blanks	UTC	27	dd-MMM-yyyy hh:mm:ss.uuuuuu
	quotation mark (")		1	uc
	newline character	terminator	1	
#11	SENSING_STOP=	keyword	13	13*uc
	quotation mark (")		1	uc
	UTC stop time of data sensing. This is the UTC stop time of the Input Level 1B/L2 Product. If not used set to 27 blanks	UTC	27	dd-MMM-yyyy hh:mm:ss.uuuuuu
	quotation mark (")		1	uc
	newline character	terminator	1	
#12	Spare (blank characters)		40	40*uc
	newline character	terminator	1	uc
<i>Orbit Information</i>				
#13	PHASE=	keyword	6	6*uc
	Phase Code: phase letter (A, B, ...) If not used set to X		1	
	newline character	terminator	1	uc



#14	CYCLE=	keyword	6	6*uc
	Cycle number. If not used set to +000		4	%+04d
	newline character	terminator	1	uc
#15	REL_ORBIT=	keyword	10	10*uc
	Relative Orbit Number at sensing start time. If not used set to +00000		6	%+06d
	newline character	terminator	1	uc
#16	ABS_ORBIT=	keyword	10	10*uc
	Absolute Orbit Number at sensing start time. If not used set to +00000		6	%+06d
	newline character	terminator	1	uc
#17	STATE_VECTOR_TIME=	keyword	18	18*uc
	quotation mark (")		1	uc
	UTC state vector time It is filled properly in case of usage of FOS Predicted Orbit information otherwise it shall be set to 27 blanks	UTC	27	dd-MMM-yyyy hh:mm:ss.uuuuuu
	quotation mark (")		1	uc
	newline character	terminator	1	
#18	DELTA_UT1=	keyword	10	10*uc
	Universal Time Correction: DUT1 = UT1 – UTC Not used for Cryosat. It shall be set to +.000000	s	8	%+08.6f
	<s>	units	3	3*uc
	newline character	terminator	1	
#19	X_POSITION=	keyword	11	11*uc
	X position in Earth Fixed Reference. If not used set to +0000000.000	m	12	%+012.3f
	<m>	units	3	3*uc
	newline character	terminator	1	
#20	Y_POSITION=	keyword	11	11*uc
	Y position in Earth Fixed Reference. If not used set to +0000000.000	m	12	%+012.3f
	<m>	units	3	3*uc
	newline character	terminator	1	



#21	Z_POSITION=	keyword	11	11*uc
	Z position in Earth Fixed Reference. If not used set to +0000000.000	m	12	%+012.3f
	<m>	units	3	3*uc
	newline character	terminator	1	
#22	X_VELOCITY=	keyword	11	11*uc
	X velocity in Earth Fixed Reference. If not used set to +0000.000000	m/s	12	%+012.6f
	<m/s>	units	5	5*uc
	newline character	terminator	1	
#23	Y_VELOCITY=	keyword	11	11*uc
	Y velocity in Earth Fixed Reference. If not used set to +0000.000000	m/s	12	%+012.6f
	<m/s>	units	5	5*uc
	newline character	terminator	1	
#24	Z_VELOCITY=	keyword	11	11*uc
	Z velocity in Earth Fixed Reference. If not used set to +0000.000000	m/s	12	%+012.6f
	<m/s>	units	5	5*uc
	newline character	terminator	1	
#25	VECTOR_SOURCE=	keyword	14	14*uc
	quotation mark (")		1	uc
	Source of Orbit State Vector Record FP = FOS predicted DN = DORIS Level 0 navigator DP = DORIS precise orbit FR = FOS Restituted DI = DORIS Preliminary		2	2*uc
	quotation mark (")		1	uc
	newline character	terminator	1	
#26	Spare (blank characters)		40	40*uc
	newline character	terminator	1	uc
<i>SBT to UTC conversion Information</i>				
#27	UTC_SBT_TIME=	keyword	13	13*uc
	quotation mark (")		1	uc



	Not used and set to 27 blanks		27	\$
	quotation mark (")		1	uc
	newline character	terminator	1	uc
#28	SAT_BINARY_TIME=	keyword	16	16*uc
	Satellite Binary Time Not used for Cryosat and it shall be set to zeros		11	+0000000000
	newline character	terminator	1	uc
#29	CLOCK_STEP =	keyword	11	11*uc
	Clock Step Not used for Cryosat and it shall be set to zeros		11	+0000000000
	<ps>	units	4	4*uc
	newline character	terminator	1	uc
#30	Spare (blank characters)		32	32*uc
	newline character	terminator	1	uc
<i>Leap Second Information</i>				
#31	LEAP.UTC=	keyword	9	9*uc
	quotation mark (")		1	uc
	UTC Time of the occurrence of the leap second. If a leap second occurred in the product window the field is set by a devoted function in the CFI EXPLORER_ORBIT library (see [EXPL_ORB-SUM] for details), otherwise it is set to 27 blanks. It corresponds to the time after the Leap Second occurrence (i.e. midnight of the day after the leap second)		27	dd-MMM-yyyy hh:mm:ss.uuuuuu
	quotation mark (")		1	uc
	newline character	terminator	1	uc
#32	LEAP_SIGN=	keyword	10	10*uc
	Leap second sign If a leap second occurred in the product window the field is set to the expected value by a devoted function in the CFI EXPLORER_ORBIT library (see [EXPL_ORB-SUM] for details), otherwise it is set to +000.	s	4	%+04d
	newline character	terminator	1	uc
#33	LEAP_ERR=	keyword	9	9*uc



	Leap second error flag. This field is always set to 0 considering that CRYOSAT products have true UTC times		1	uc
	newline character	terminator	1	uc
#34	Spare (blank characters)		40	40*uc
	newline character	terminator	1	uc
<i>Product Confidence Data Information</i>				
#35	PRODUCT_ERR=	keyword	12	12*uc
	Product Error Flag set to 1 if errors have been reported in the product		1	uc
	newline character	terminator	1	uc
<i>Product Size Information</i>				
#36	TOT_SIZE=	keyword	9	9*uc
	Total size of the product	bytes	21	%+021d
	<bytes>	units	7	7*uc
	newline character	terminator	1	Uc
#37	SPH_SIZE=	keyword	9	9*uc
	Length of the SPH	bytes	11	%+011d
	<bytes>	units	7	7*uc
	newline character	terminator	1	Uc
#38	NUM_DSD=	keyword	8	8*uc
	Number of Data Set Descriptors, including spares and all other types of DSDs		11	%+011d
	newline character	terminator	1	Uc
#39	DSD_SIZE=	keyword	9	9*uc
	Length of each DSD	bytes	11	%+011d
	<bytes>	units	7	7*uc
	newline character	terminator	1	Uc
#40	NUM_DATA_SETS=	keyword	14	14*uc
	Number of attached Data Sets (note that not all the DSDs have a DS attached)		11	%+011d
	newline character	terminator	1	Uc
#41	CRC=	keyword	4	4*uc
	Cyclic Redundancy Code computed as overall value of all records of the Measurement Data Set. If not computed it shall be set to -00001		6	%+06d
	newline character	terminator	1	Uc

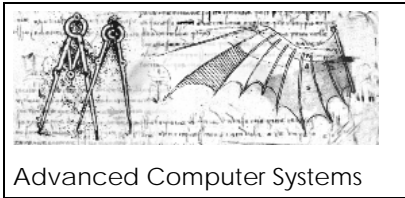

Advanced Computer Systems



Instrument Processing Facility L2

Doc. No.: *CS-RS-ACS-GS-5123*
 Issue: *2.1*
 Date: *18 February 2008*
 Page: *30*

#42	Spare (blank characters)		29	29*uc
	newline character	terminator	1	uc
	TOTAL		1247	

Table 2.3.1-1 Product MPH Description

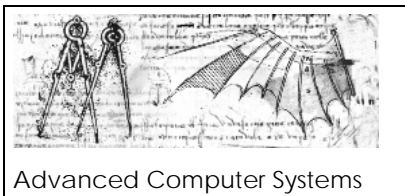

2.3.2 Specific Product Header (SPH)

The Specific Product Header is an ASCII header common to all Level 2 products.

Field #	Description	Units	Bytes	Data Type
<i>Product description and identification</i>				
#1	SPH_DESCRIPTOR=	keyword	15	15*uc
	quotation mark (")		1	uc
	ASCII string describing the product		28	28*uc Product ID SPECIFIC HEADER See Product ID in table 3-1
	quotation mark (")		1	uc
	newline character	terminator	1	uc
<i>Product Time information</i>				
#2	START_RECORD_TAI_TIME=	keyword	22	22*uc
	quotation mark (")		1	uc
	TAI of the first record in the Main MDS of this product	TAI	27	dd-MMM-yyyy hh:mm:ss.uuuuuu
	quotation mark (")		1	uc
	newline character	terminator	1	uc
#3	STOP_RECORD_TAI_TIME=	keyword	21	21*uc
	quotation mark (")		1	uc
	TAI of the last record in in the Main MDS of this product	TAI	27	dd-MMM-yyyy hh:mm:ss.uuuuuu
	quotation mark (")		1	uc
	newline character	terminator	1	uc
<i>Product Orbit Information</i>				
#4	ABS_ORBIT_START=	Keyword	16	16*uc
	Absolute Orbit Number at Product Start Time		6	%06d
	Newline character	terminator	1	uc



#5	REL_TIME_ASC_NODE_START =	Keyword	24	24*uc
	Relative time since crossing ascending node time relative to start time of data sensing	s	11	%011.6f
	<s>	units	3	3*uc
	Newline character	terminator	1	Uc
#6	ABS_ORBIT_STOP =	Keyword	15	15*uc
	Absolute Orbit Number at Product Stop Time		6	%06d
	Newline character	terminator	1	uc
#7	REL_TIME_ASC_NODE_STOP =	Keyword	23	23*uc
	Relative time since crossing ascending node time relative to stop time of data sensing	s	11	%011.6f
	<s>	units	3	3*uc
	Newline character	terminator	1	uc
#8	EQUATOR_CROSS_TIME_UTC =	Keyword	23	23*uc
	Quotation mark (")		1	uc
	Time of Equator crossing at the ascending node of the sensing start time	UTC	27	dd-MMM-yyyy hh:mm:ss.uuuuuu
	Quotation mark (")		1	uc
	Newline character	terminator	1	uc
#9	EQUATOR_CROSS_LONG =	Keyword	19	19*uc
	Longitude of Equator Crossing at the ascending node of the sensing start time (positive East, 0 = Greenwich) referred to WGS84	s	11	%+011d
	<10-6degE>	units	10	10*uc
	Newline character	terminator	1	uc
#10	ASCENDING_FLAG =	Keyword	15	15*uc
	Orbit Orientation at the sensing start time A= Ascending D= Descending		1	uc
	Newline character	terminator	1	uc
<i>Product Location Information</i>				
#11	START_LAT =	keyword	10	10*uc
	WGS84 latitude of the first record in the Main MDS (positive north)	[10-6 deg]	11	%+011d



	<10-6degN>	units	10	10*uc
	newline character	terminator	1	uc
#12	START_LONG=	keyword	11	11*uc
	WGS84 longitude of the first record in the Main MDS (positive East, 0 = Greenwich)	[10-6 deg]	11	%+011d
	<10-6degE>	units	10	10*uc
	newline character	terminator	1	uc
#13	STOP_LAT=	keyword	9	9*uc
	WGS84 latitude of the last record in the Main MDS (positive north)	[10-6 deg]	11	%+011d
	<10-6degN>	units	10	10*uc
	newline character	terminator	1	uc
#14	STOP_LONG=	keyword	10	10*uc
	WGS84 longitude of the last record in the Main MDS (positive East, 0 = Greenwich)	[10-6 deg]	11	%+011d
	<10-6degE>	units	10	10*uc
	newline character	terminator	1	uc
#15	Spare (blank characters)	ascii	50	50*uc
	newline character	terminator	1	uc
<i>Level 1B Quality information</i>				
#16	L1_PROC_FLAG=	keyword	13	13*uc
	Processing errors significance flag (1 or 0). 1 if the percentage of L1B records free of processing errors is less than the acceptable threshold		1	uc
	newline character	terminator	1	uc
	#17	L1_PROCESSING_QUALITY=	keyword	22
Percentage of quality checks successfully passed during the L1B processing (max allowed +10000)		[10-2 %]	6	%+06d
<10-2%>		units	7	7*uc
newline character		terminator	1	uc
#18	L1_PROC_THRESH=	keyword	15	15*uc
	Minimum acceptable percentage of quality threshold that must be passed during L1B processing (max allowed +10000)	[10-2 %]	6	%+06d



#19	<10-2%>	units	7	7*uc
	newline character	terminator	1	uc
	NUM_L1_DSR_PROC=		16	16*uc
	Number of L1B Data Set Records analysed		11	%+011d
	newline character	terminator	1	uc
#20	Spare (blank characters)	ascii	37	37*uc
	newline character	terminator	1	uc
<i>SIRAL Instrument Configuration</i>				
#21	INSTR_ID=	keyword	9	9*uc
	quotation mark (")		1	uc
	Instrument identifier		1	1*uc A = SIRAL Nominal B = SIRAL Redundant
	quotation mark (")		1	uc
	newline character	terminator	1	uc
	<i>SIRAL Mode Statistics</i>			
#22	LRM_MODE_PERCENT=	keyword	17	17*uc
	Percentage of input L1B records detected in LRM mode	[10-2 %]	6	%+06d
	<10-2%>	units	7	7*uc
	newline character	terminator	1	uc
#23	SAR_MODE_PERCENT=	keyword	17	17*uc
	Percentage of input L1B records detected in SAR mode	[10-2 %]	6	%+06d
	<10-2%>	units	7	7*uc
	newline character	terminator	1	uc
#24	SARIN_MODE_PERCENT=	keyword	19	19*uc
	Percentage of input L1B records detected in SARIN mode	[10-2 %]	6	%+06d
	<10-2%>	units	7	7*uc
	newline character	terminator	1	uc
#25	OTHER_MODES_PERCENT=	keyword	20	20*uc
	Percentage of input L1B records detected in any other mode	[10-2 %]	6	%+06d
	<10-2%>	units	7	7*uc
	newline character	terminator	1	uc
#26	Spare (blank characters)	ascii	50	50*uc



	newline character	terminator	1	uc
<i>SIRAL Surface Statistics</i>				
#27	OPEN_OCEAN_PERCENT=	keyword	19	19*uc
	Percentage of records detected on open ocean or semi-enclosed seas	[10-2 %]	6	%+06d
	<10-2%>	units	7	7*uc
	Newline character	terminator	1	uc
#28	CLOSE_SEA_PERCENT=	keyword	18	18*uc
	Percentage of records detected on close seas or lakes	[10-2 %]	6	%+06d
	<10-2%>	units	7	7*uc
	Newline character	terminator	1	Uc
#29	CONTINENT_ICE_PERCENT=	keyword	22	22*uc
	Percentage of records detected on continental ice	[10-2 %]	6	%+06d
	<10-2%>	units	7	7*uc
	Newline character	terminator	1	Uc
#30	LAND_PERCENT=	keyword	13	13*uc
	Percentage of records detected on land	[10-2 %]	6	%+06d
	<10-2%>	units	7	7*uc
	Newline character	terminator	1	Uc
#31	Spare (blank characters)	ascii	50	50*uc
	newline character	terminator	1	uc
<i>Level 2 Processing information</i>				
#32	L2_PROD_STATUS=	keyword	15	15*uc
	Complete/Incomplete Product Completion Flag (0 or 1).		1	uc
	1 if the Product as a duration shorter than the input product.			
	newline character	terminator	1	uc
#33	L2_PROC_FLAG=	keyword	13	13*uc
	Processing errors significance flag (1 or 0).		1	uc
	1 if the percentage of DSR free of processing errors is less than the acceptable threshold			
	newline character	terminator	1	uc
#34	L2_PROCESSING_QUALITY=	keyword	22	22*uc

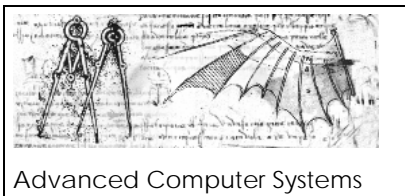

#35	Percentage of quality checks successfully passed during Level 1B processing (max allowed +10000)	[10-2 %]	6	%+06d
	<10-2%>	units	7	7*uc
	newline character	terminator	1	uc
	L2_PROC_THRESH=	keyword	15	15*uc
	Minimum acceptable percentage of quality threshold that must be passed during Level 1B processing (max allowed +10000)	[10-2 %]	6	%+06d
	<10-2%>	units	7	7*uc
	newline character	terminator	1	Uc
#36	Spare (blank characters)	ascii	50	50*uc
	newline character	terminator	1	Uc
	TOTAL			
	<i>DSD Section</i>			

Table 2.3.2-1 Product SPH Description

Notes:

- ❑ Fields 16 – 17 – 18 – 19 are aimed to provide summary quality information of the input L1B that was the source for the higher L2 processing. These fields are derived from the input L1B and transferred in the output L2 SIR_LRM_2_ – SIR_SAR_2A – SIR_SIN_2_ - SIR_SID_2_ and SIR_LRMI2_ - SIR_SARI2A – SIR_SINI2_ - SIR_SIDI2_.

For the Level 2 SIR_SAR_2B and SIR_SARI2B the fields 16 – 17 – 18 - 19 are copied from the corresponding fields of the SIR_SARI2A.

For the Level 2 GDR (SIR_GDR_2A and SIR_GDR_2B) field 17 is computed from the corresponding fields of the input products taking in to account the number of the DSR records in the input file which is available in field 19 of the input L2 products and recomputing the percentage as a weighted sum over the input products. Field 18 matches the threshold specified in the processor configuration file for the L2 GDR processing and field 16 is then computed accordingly from field 17 and 19 using the threshold level in field 18.

- ❑ Fields 22 – 23 – 24 - 25 are mainly aimed for the GDR products (which are merged products) providing statistical information on the amount of data in the product belonging to the LRM –

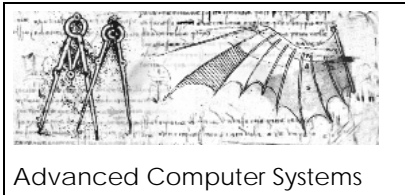

SAR – SARIN or other modes. These fields will be computed from the Mode information that is available in both L1B and L2 records.

- ❑ Fields 32 – 33 – 34 – 35 provide summary quality information of the Level 2 product L2. The calculation of the quality parameters is based on the analysis of the MCD field available in the records.

The DSD Section shall actually be divided in two principal sections, Measurement DSD, indicated as DSD (M) and Reference DSD, indicated as DSD (R). The general structure of a DSD is shown in table 2.3.2-2. The size of a DSD is 280 bytes.

#N	<i>DSD</i>			
#N.1	DS_NAME=	keyword	8	8*uc
	quotation mark		1	uc
	Name describing the Data Set		28	28*uc
	quotation mark		1	uc
	newline character	terminator	1	uc
#N.2	DS_TYPE=	keyword	8	8*uc
	Type of Data Set. It can be: M = Measurement R = Reference		1	uc
	newline character	terminator	1	uc
	<i>External product reference</i>			
#N.3	FILENAME=	keyword	9	9*uc
	quotation mark		1	uc
	Name of the Reference File. Used if DS_TYPE is set to R. It is left justified with trailer blanks. The file name includes the extension. If not used it is set to 62 blanks.		62	62*uc
	quotation mark		1	uc

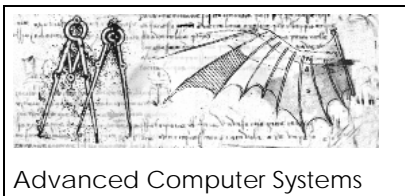

	newline character	terminator	1	uc
<i>Position and size of DS</i>				
#N.4	DS_OFFSET=	keyword	10	10*uc
	Length in bytes of MPH + SPH (including DSDs) + DS size of previous Data Set (if any).	byte	21	%+021d
	<bytes>	units	7	7*uc
	newline character	terminator	1	uc
#N.5	DS_SIZE=	keyword	8	8*uc
	Length in bytes of the attached Data Set Used if DS_TYPE is set to M If not used set to 0	byte	21	%+021d
	<bytes>	units	7	7*uc
	newline character	terminator	1	uc
<i>Number and length of DSRs</i>				
#N.6	NUM_DSR=	keyword	8	8*uc
	Number of Data Set Records		11	%+011d
	newline character	terminator	1	uc
#N.7	DSR_SIZE=	keyword	9	9*uc
	Length in bytes of the Data Set Record If not used set to +0 If variable set to -1	byte	11	%+011d
	<bytes>	units	7	7*uc
	newline character	terminator	1	uc
#N.8	Spare	ascii	32	32*uc
	newline character	terminator	1	uc

Table 2.3.2-2 Generic DSD Description

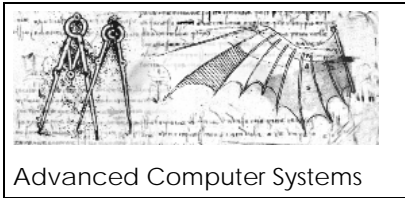

For convenience the Measurement DSD should appear first in the list, followed by all the needed Reference DSDs.

The effective size of the SPH in number of bytes is defined in field #37 SPH_SIZE of the MPH.

The total number of DSD Descriptors is defined in field #38 of the MPH.

The number of Measurement DSDs is defined in field #40 of the MPH.

For the Measurement Data Sets the DSD (M) may have the following options for the DS_NAME:

<i>DS_NAME for Measurement DSD</i>
SIR_LRM_L2
SIR_FDM_L2
SIR_SAR_L2A
SIR_SAR_L2B
SIR_SIN_L2
SIR_SID_L2
SIR_GDR_2A
SIR_GDR_2B
SIR_LRM_L2_I
SIR_FDM_L2_I
SIR_SAR_L2A_I
SIR_SAR_L2B_I
SIR_SIN_L2_I
SIR_SID_L2_I

Table 2.3.2-3 DS Names for Measurement Data Sets DSD

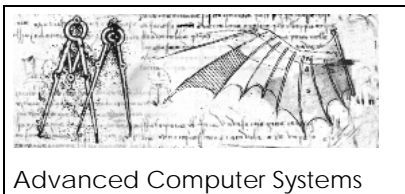

Advanced Computer Systems



Instrument Processing Facility L2

Doc. No.: CS-RS-ACS-GS-5123
 Issue: 2.1
 Date: 18 February 2008
 Page: 40

For the Reference DSDs it is proposed to include all the reference DSDs of the source L1B file, in order to provide a Level 2 product which contains all the references to the files that were used along the IPF1 / IPF2 processing chain to generate the product. In addition some new DSDs have to be introduced and the complete list is supplied here after:

CONSTANTS_FILE	Constants File
PROC_CONFIG_PARAMS_FILE	Processor Configuration Parameters File
SIRAL_LEVEL_0_FILE	SIRAL LEVEL 0 File from which the L1B product was created
SIRAL_LEVEL_1B_FILE	SIRAL LEVEL 1B File from which the product was created
SIRAL_LEVEL_2_FILE	SIRAL LEVEL 2 File from which the GDR product was created
SCENARIO_FILE	Orbit Scenario File
ORBIT_FILE	Orbit Data File
STAR_TRACKER_LEVEL_0_FILE	Star Tracker Level 0 File
DORIS_USO_DRIFT_FILE	DORIS USO Drift File
FOS_PLATFORM_DATA_FILE	FOS Platform Data File
FOS_HK_TM_FILE	FOS Sorted HouseKeeping Telemetries File
IPF_RA_DATABASE_FILE	Instrument Characterization Data File
CALIBRATION_TYPE_1_FILE	File Product containing CAL_1 corrections
CALIBRATION_TYPE_2_FILE	File Product containing CAL_2 corrections
CALIBRATION_TYPE_EXOTIC	File Product containing Exotic CAL1 SARIN corrections
OCEAN_TIDE_FILE	File for Ocean Tide
TIDAL_LOADING_FILE	File for Tidal Loading
EARTH_TIDE_FILE	CartWright File
POLE_TIDE_FILE	Pole Location Data File
SURFACE_TYPE_FILE	Surface Type Map File
S1S2_PRESSURE_00H_MAP	Climatology Pressure Grids for each month at 00 hh.
S1S2_PRESSURE_06H_MAP	Climatology Pressure Grids for each month at 06 hh.
S1S2_PRESSURE_12H_MAP	Climatology Pressure Grids for each month at 12 hh.
S1S2_PRESSURE_18H_MAP	Climatology Pressure Grids for each month at 18 hh.
S1_TIDE_AMPLITUDE_MAP	S1 tide grid of monthly mean of global amplitude
S2_TIDE_AMPLITUDE_MAP	S2 tide grid of monthly mean of global amplitude
S1_TIDE_PHASE_MAP	S1 tide grid of monthly mean of global phase
S2_TIDE_PHASE_MAP	S2 tide grid of monthly mean of global phase
MODIFIED_DIP_MAP_FILE	Modified Dip Map File used for BENT Ionospheric Correction
IONO_COEFFICIENTS_FILE	Ionospheric Coefficients file used for BENT Ionospheric Correction
SAI_FILE	Solar Activity Index File used for BENT Ionospheric Correction
GPS_IONO_MAP	GPS Ionospheric Map Data
SURFACE_PRESSURE_FILE	Surface Pressure File for Meteo Correction
MEAN_PRESSURE_FILE	Mean Pressure File for Meteo Correction
WET_TROPOSPHERE_FILE	Wet Troposphere File for Meteo Correction
DRY_TROPOSPHERE_FILE	Dry Troposphere File for Meteo Correction
U_WIND_FILE	U Wind component File for Meteo Correction
V_WIND_FILE	V Wind component File for Meteo Correction
METEO_GRID_DEF_FILE	Meteo Grid Definition File
DEM_MODEL_FILE	DEM Model File
SLOPE_MODEL_FILE	Surface Slope File
MEAN_SEA_SURFACE_FILE	Mean Sea Surface File
SNOW_DEPTH_CLIMATE_FILE	Snow depth Climatology File
SEA_ICE_CONCENTRATION_FILE	Sea Ice Concentration File
GEOID_FILE	Geoid File
ODLE_FILE	Ocean Depth/Land Elevation File
SEA_STATE_BIAS_FILE	Sea State Bias File

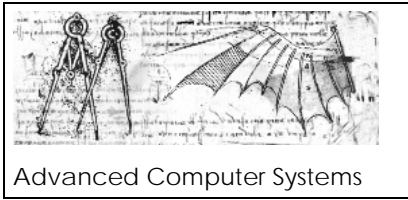

Instrument Processing Facility L2

Doc. No.: *CS-RS-ACS-GS-5123*
Issue: *2.1*
Date: *18 February 2008*
Page: *41*

Table 2.3.2-5 DS Names for Reference DSDs

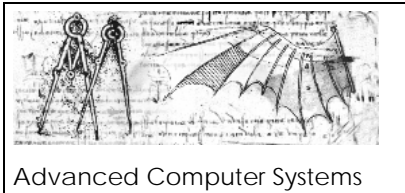

2.3.3 Measurement Data Set Record (MDS)

The L2 data is the main output from the L2 processor. This is a compact Geophysical Data Record designed to minimise the volume of data distributed to Users. However, a second L2 data set can be output which is called 'Intermediate L2' and is identified with an 'I' in the filetype: SIR_XXXI2X. This dataset contains many more parameters and flags and is consequentially much larger. The intermediate format is required as the input to the second pass of the L2 SAR processing for Sea Ice areas.

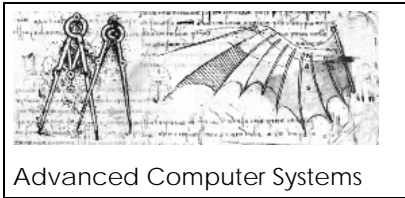

2.3.3.1 L2 MDS Records Layout

The L2 Measurement Dataset has a single format which is independent of mode and thus applies to products SIR_LRM_2_ , SIR_SAR_2A , SIR_SAR_2B , SIR_SIN_2_ , SIR_SID_2_ , SIR_GDR_2A , SIR_GDR_2B. However the meaning of some fields is mode dependent.

The L2 format has been designed with the goal of minimising data volume. There is a 'Blocking' of high-rate data in each record (as in L1b). This allows measurements to be available at the highest rate (approx 21Hz) without repetition of slowly varying corrections factors such as the Dry Tropospheric Range Correction.

Product parameters are grouped according to function into 3 sub-structures as follows:

- Location Group time and orbit location plus the measurement mode
- External Corrections Group geophysical corrections
- Measurements Group derived from instrument measurement parameters (structure is repeated 20 times per record).

Note that instrument mode switching and data partitioning can occur at the highest rate. Sometimes a record will contain less than 20 measurements. In this case the remaining unused blocks in the measurement group are flagged and filled with zeros.

The record structure is illustrated in the following diagram. The repetition frequency of the first two sub-structures is 1 but the Measurements Group sub-structure is repeated 20 times in each MDS record.

Repetition of sub-structure		
x1	x1	x20
Time & Orbit Group	External Corrections	Measurement Group

Figure 2.3.3.1-1 Level2 MDS Layout



Advanced Computer Systems



Instrument Processing Facility L2

Doc. No.: CS-RS-ACS-GS-5123
 Issue: 2.1
 Date: 18 February 2008
 Page: 44

ID	Descriptor	Unit	Type	Size (bytes)	Tot. Size (bytes)
Time and Orbit group					
1	Data Record Time (MDSR Time Stamp)	TAI	sl+2*ul	12	12
2	Measurement mode (LRM/ SAR/ SARin/ SID)	-	ull	8	8
3	Latitude of Orbit	10-1 μ -degree (see note 1)	sl	4	4
4	Longitude of Orbit	10-1 μ -degree (see note 1)	sl	4	4
5	Altitude of COG above reference ellipsoid (interpolated value)	Mm	sl	4	4
6	Mispointing attitude angle	milli degrees	ss	2	2
7	Number of valid Measurements in this record	-	us	2	2
Sub-total size					36
External Corrections group					
8	Dry Tropospheric Correction	mm	ss	2	2
9	Wet Tropospheric Correction	mm	ss	2	2
10	Inverse Barometric Correction	mm	ss	2	2
11	Ionospheric Correction	mm	ss	2	2
12	Sea State Bias (EM Bias)	mm	ss	2	2
13	Ocean Tide	mm	ss	2	2
14	Long Period Equilibrium Ocean Tide	mm	ss	2	2
15	Ocean Loading Tide	mm	ss	2	2
16	Solid Earth Tide	mm	ss	2	2
17	Geocentric Polar Tide	mm	ss	2	2
18	Surface type flag	-	ull	8	8
19	MSS / Geoid from model	mm	sl	4	4
20	Snow Depth	mm	ss	2	2
21	Corrections status flags	-	us	2	2
22	Spare 1 (SWH)		ss	2	2
23	Spare 2 (Wind speed)		ss	2	2
Sub-total size					40
Measurements group - Repeated 20 times					
24	delta time (to give 20Hz times)	μ sec	sl	4	4
25	Latitude of measurement	10-1 μ -degree (see note 1)	sl	4	4
26	Longitude of measurement	10-1 μ -degree (see note 1)	sl	4	4

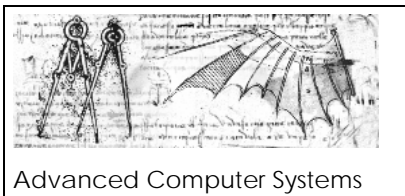

27	Height of surface w.r.t. ellipsoid	mm	sl	4	4
28	Interpolated sea Surface Height Anomaly	mm	ss	2	2
29	Backscatter Sigma 0	dB/100 (see note 2)	ss	2	2
30	Peakiness	1/100	us	2	2
31	Freeboard	mm	ss	2	2
32	Number of Echoes or Beams averaged	-	us	2	2
33	Quality flags	-	us	2	2
Sub-total size					28x20
Total Record Size					636

- 1) 10^{-1} degree is an exotic unit exclusively used at binary record level to improve resolution of the lat and long fields
- 2) 10^{-2} dB is an exotic unit used for db-units related fields.

Table 2.3.3.1-1 L2 MDS

Fields Description

Field 1) MDSR Time Stamp - for the first measurement of the 20 in each L2 record. Corresponding to time when the satellite is passing overhead of the centre of the altimeters' footprint, as defined by Latitude and Longitude in [field](#) & [field](#) To get the times for the remaining 19 measurements the delta time in [field](#) must be added. See [section](#) for a format definition.

Field 2) Measurement Mode - Identifies the SIRAL instrument measurement mode. Each of 20 measurements are flagged using 3 bits. Altogether this uses 61 out of 64 bits. see Table 2.3.3.1-2

Definition	PDS Bit	SS Bit	Setting
Measurement mode - for first record, of 20 in the measurement group	63-61	0-2	000 = 0 = Other mode (calibration, acquisition, etc...) or unknown 001 = 1 = LRM 010 = 2 = SAR 011 = 3 = SARin 100 = 4 = SID (SARin degraded case)
Measurement mode - for second record, of 20 in the measurement group	60-58	3-5	as above
Measurement mode - for third record, of 20 in the measurement group	57-55	6-8	as above
etc for records 4 to 19	etc	etc	as above
Measurement mode - for 20th record, of 20 in the measurement group	6-4	57-59	as above
SIRAL_Identifier	3	60	0 = Nominal 1 = Redundant
unused	2-0	61-63	set to 0

 <p>Advanced Computer Systems</p>		<p><i>Instrument Processing Facility L2</i></p> <p>Doc. No.: <i>CS-RS-ACS-GS-5123</i> Issue: <i>2.1</i> Date: <i>18 February 2008</i> Page: <i>46</i></p>
---	---	--

Table 2.3.3.1-2 Mode ID

- Field 3) Latitude of Orbit - Corresponding to the nadir position at the time of the 1Hz time stamp. Units are 10^{-1} μ degrees.
- Field 4) Longitude of Orbit - (as for Latitude).
- Field 5) Altitude - the Altitude of the Satellite CoG above reference ellipsoid at Nadir.
- Field 6) Mispointing angle - attitude angle between the antenna pointing (real beam direction vector) and the nadir direction.
- Field 7) Number of valid Measurements in this record - shows the number of high-rate measurements in this record. Normally this will be 20 but at the end of a data segment may be less.
- Field 8) Dry Tropospheric Correction - to be added to range measurement to correct for the propagation delay to the radar pulse, caused by the dry-gas component of the Earth's atmosphere.
- Field 9) Wet Tropospheric Correction - to be added to range measurement to correct for the propagation delay to the radar pulse, caused by the H2O component of the Earth's atmosphere.
- Field 10) Inverse Barometric Correction - to be added to range measurement to correct for the depression of the ocean surface caused by the local barometric pressure.
- Field 11) Ionospheric Correction - to be added to range measurement to correct for the delay to the Radar pulse caused by free electrons in the ionosphere. Computed from a simple model in NRT data or from GPS satellite derived (GIM) model in normal processing.
- Field 12) Sea State Bias correction - (a.k.a. EM bias correction) An empirical correction proportional to the significant wave height which compensates for the asymmetric shape of ocean waves . This is computed by the geophysical CFI library.
- Field 13) Ocean Tide - (component of total ocean tide) to be added to the range to remove the effect of local tide and adjust the measurement to the mean sea surface.
- Field 14) Long-Period equilibrium Ocean Tide - (component of total ocean tide) to be added to the range to remove the effect of local tide and adjust the measurement to the mean sea surface.



- Field 15) Ocean Loading Tide - to be added to the range to remove the effect of local tidal distortion to the Earth's crust.
- Field 16) Solid Earth Tide - to be added to the range to remove the effect of local tidal distortion in the Earth's crust.
- Field 17) Geocentric Polar Tide - to be added to the range to remove a long-period distortion of the Earth's crust. Although called a 'tide' this is in fact caused by variations in centrifugal force as the Earth's rotational axis moves its geographic location.
- Field 18) Surface type flag - enumerated key to classify surface at nadir provided by a model. The information is packed into 3 bits allowing a number range of 0-7. To flag all 20 measurements in a record 60 bits are needed hence this field is a 8- byte, or long-long integer. Note this flag is distinct from the surface discrimination in the SAR processing. The 4 unused bits are set to zero. See Table 2.3.3.1-3

Value	Definition
0	Open Ocean
1	Closed Sea
2	Continental Ice
3	Land
4-7	currently unused

Table 2.3.3.1-3 Surface Type Flag

- Field 19) MSS/Geoid from model : Over Ocean (field Surface Type = 0 or 1) this is the surface height from the MSS model. Over Land (field Surface Type = 2 or 3) this is the Geoid model height from the CFI library.
- Field 20) Snow Depth : in mm merged from a climatology model data. This can be used (by L2 product User) to adjust the freeboard estimate to account for snow-loading.
- Field 21) Corrections status flag - used to show validity of 1Hz corrections. This flag is at 1Hz and so can only indicate the validity of 1Hz parameters. The corrections have been used to derive the surface height (field) in the L2 products. See table 2.3.3.1-4.

Definition	PDS Bit	SS Bit	Setting
Dry Tropospheric delay correction	15	0	0 = OK, 1 = invalid

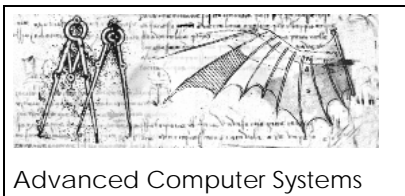

Wet Tropospheric delay correction	14	1	0 = OK, 1 = invalid
Inverse Barometer correction	13	2	0 = OK, 1 = invalid
Ionospheric delay correction	12	3	0 = OK, 1 = invalid
Sea State Bias correction	11	4	0 = OK, 1 = invalid
Ocean tide	10	5	0 = OK, 1 = invalid
Long Period Equilibrium Ocean tide	9	6	0 = OK, 1 = invalid
Ocean loading tide	8	7	0 = OK, 1 = invalid
Solid Earth tide	7	8	0 = OK, 1 = invalid
Geocentric Polar tide	6	9	0 = OK, 1 = invalid
Surface Type Flag	5	10	0 = OK, 1 = invalid
Snow Depth valid	4	11	0 = OK, 1 = invalid
MSS / Geoid from model	3	12	0 = OK, 1 = invalid
SWH valid	2	13	0 = OK, 1 = invalid
Wind speed valid	1	14	0 = OK, 1 = invalid
Unused	0	15	set to 0

Table 2.3.3.1-4 Corrections Status Flag

Field 22) Spare1 - reserved for SWH.

Field 23) Spare2 - reserved for wind speed.

For the 20Hz measurements note that sometimes this will be empty (zero-filled) when measurements end part-way through a block of 20. This condition is indicated by the Quality flags in [field](#)

Field 24) delta Time - adds to the 1 Hz time stamp (in [field](#)) to give the correct time for each of the 20 measurement blocks. Will be set to zero if block is empty.

Field 25) Measurement Latitude : of the echoing point position - this includes the x-track offset for SARin measurements and the slope-corrected position for LRM measurements. Units are 10^{-1} µdegrees. Note Latitude at Nadir is preserved in [field](#)

Field 26) Measurement Longitude : of the echoing point position - this includes the x-track offset for SARin measurements and the slope-corrected position for LRM measurements. Units are 10^{-1} µdegrees. Note Longitude at Nadir is preserved in [field](#)

Field 27) Height of surface : At measurement point w.r.t. the reference ellipsoid.

Field 28) Interpolated Sea Surface Height Anomaly: the ocean height anomaly defined by comparing the

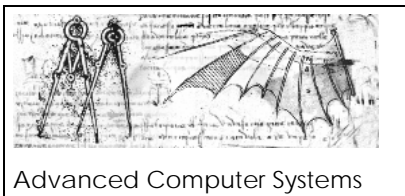

interpolated ocean height from the SAR processing with the MSS from the model. Note that the interpolated ocean height is different from the surface height in [field](#)

Field 29) Sigma 0 : fully corrected including instrument gain corrections and retracker correction.

Field 30) Peakiness : of the echo in the L1b product. Note that this will require different interpretation for SAR and SARin echoes which are not the 'usual' pulse-limited echo shape.

Field 31) Freeboard : SAR mode computed freeboard of the Sea Ice. Initially (e.g. for launch plus 1 year) this will be set to '-9999', when there is greater confidence in the knowledge of the Arctic basin sea surface height then freeboard will be computed in the L2 products. Freeboard will be zero when the SAR Discriminator (in [field](#)) indicates 'Ocean' or 'Lead', and '-9999' when the SAR Discriminator indicates 'Unknown'. Note that Freeboard can be a small negative value when there is sufficient snow-loading on thin ice. Set to 0 in SARin and LRM modes.

Field 32) Number of Echoes/beams averaged : In LRM mode this is the number of echoes which have been averaged to make 1 measurement (normally). In SAR and SARin mode it is the number of Doppler beams which have been stacked to derive each measurement. Near the beginning and end of each section of SAR or SARin mode operation this number will reduce below the nominal value and there is a corresponding decrease in the signal to noise ratio of the waveform.

Field 33) Measurement Quality Flags - indicating the quality of the 20Hz measurement parameters. See table 2.3.3.1-5.

Definition	PDS Bit	SS Bit	Setting
Block degraded	15	0	0= OK, 1= degraded or zero-filled for padding. (set if the block should not be processed)
Orbit error	14	1	0 = OK, 1 = an error detected
Orbit discontinuity	13	2	0= OK, 1= Orbit discontinuity occurred (e.g. gap)
Height error	12	3	0 = OK, 1 = error in the height derivation.
Interpolated sea surface height anomaly error	11	4	0 = no, 1 = error
Calibration warning	10	5	0 = no, 1 = non-nominal calibration correction
Backscatter error	9	6	0 = no, 1 =error
Peakiness error	8	7	0 = no, 1 = error
Freeboard error	7	8	0 = OK, 1 = invalid
SAR discriminator = Ocean	6	9	0 = no, 1 = yes
SAR discriminator = lead	5	10	0 = no, 1 = yes
SAR discriminator = Ice	4	11	0 = no, 1 = yes
SAR discriminator = Unknown	3	12	0 = no, 1 = yes

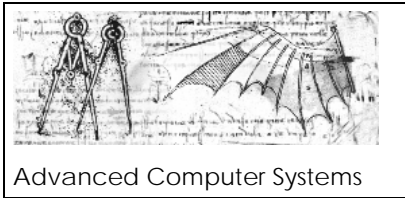

Instrument Processing Facility L2

Doc. No.: *CS-RS-ACS-GS-5123*
 Issue: *2.1*
 Date: *18 February 2008*
 Page: *50*

SARin x-track angle error	2	13	0 = no, 1 = ambiguous angle
Receive Ch1 error for SARin	1	14	0= OK, 1= degraded or missing
Receive Ch2 error for SARin	0	15	0= OK, 1= degraded or missing

Table 2.3.3.1-5 Measurement Quality Flags



Advanced Computer Systems



Instrument Processing Facility L2

Doc. No.: CS-RS-ACS-GS-5123
 Issue: 2.1
 Date: 18 February 2008
 Page: 52

ID	Descriptor	Unit	Type	Size (bytes)	Tot. Size (bytes)
Time and Orbit group					
1.	Data Record Time (MDSR Time Stamp)	TAI	sl+2*ul	12	12
2.	USO Correction factor (definition tbd)	(ratio)	sl	4	4
3.	Mode ID (Instrument mode information)	-	us	2	2
4.	Source Sequence Counter (from telemetry)	-	us	2	2
5.	Instrument Config (including loop status)	-	ul	4	4
6.	Surface Sample counter (Record Counter)	-	ul	4	4
7.	Latitude of measurement	10 ⁻¹ μ-degree (see note 1)	sl	4	4
8.	Longitude of measurement	10 ⁻¹ μ-degree (see note 1)	sl	4	4
9.	Altitude of COG above reference ellipsoid (interpolated value)	mm	sl	4	4
10.	Instantaneous altitude rate derived from orbit	mm/sec	sl	4	4
11.	Satellite velocity vector[3] (in IERF)	mm/sec	sl	3*4	12
12.	Real beam direction vector[3] (in CRF)	μm	sl	3*4	12
13.	Interferometer baseline vector[3] (in CRF)	μm	sl	3*4	12
14.	Level 2 Measurement Confidence Data (flag word)	-	ul	4	4
Sub-total size					84
Measurements group					
15.	Height of surface w.r.t. ellipsoid	mm	sl	4	4
16.	Sigma 0	dB/100 (see note 2)	sl	4	4
17.	spare (reserved for future use)	-	sl	4	4
18.	Peakiness	1/100	sl	4	4
19.	Retracked range correction	mm	sl	4	4
20.	Retracked Sigma 0 correction	dB/100 (see note 2)	sl	4	4
21.	Retracker output 3	Tbd	sl	4	4
22.	Retracker output 4	Tbd	sl	4	4
23.	Retracker output 5	Tbd	sl	4	4
24.	Retracker output 6	Tbd	sl	4	4
25.	Retracker output 7	Tbd	sl	4	4
26.	Retracker output 8	Tbd	sl	4	4
27.	Retracker output 9	Tbd	sl	4	4
28.	Retracker output 10	Tbd	sl	4	4



29.	Retracker output 11	Tbd	sl	4	4
30.	Retracker output 12	Tbd	sl	4	4
31.	Retracker output 13	Tbd	sl	4	4
32.	Power echo shape parameter	dB/100 (see note 2)	sl	4	4
33.	Beam behaviour parameter [50]	-	ss	50*2	100
34.	x-Track Angle (interferometric angle computed at Retracker point)	μ radians	sl	4	4
35.	Coherence (at Retracker point)	1/1000	sl	4	4
36.	Interpolated Ocean Height	mm	sl	4	4
37.	Freeboard (initially =0)	mm	sl	4	4
38.	Surface Height Anomaly	mm	sl	4	4
39.	Interpolated Sea Surface Height Anomaly	mm	sl	4	4
40.	Interpolation error for Ocean Height	mm	us	2	2
41.	Number of interpolation points used -forward	-	us	2	2
42.	Number of interpolation points used -backward	-	us	2	2
43.	Radius of interpolation -forward (in time)	ms	us	2	2
44.	Radius of interpolation -backward (in time)	ms	us	2	2
45.	Interpolation error flag	-	us	2	2
46.	Measurement mode (SAR / SARin / LRM)	-	ul	4	4
47.	Measurement Quality Flags	-	ul	4	4
48.	Retracker Flags	-	ul	4	4
49.	Height Status Flags	-	ul	4	4
50.	SAR Freeboard Status Flags	-	ul	4	4
51.	Number of Echoes or Beams averaged	-	us	2	2
52.	Spare (reserved for wind speed)	-	us	2	2
53.	Measurement Spares	-	uc	12x1	12
Sub-total size					244
Auxiliary Measurements group					
54.	Ice concentration parameter	%/1000	sl	4	4
55.	Snow Depth	mm	sl	4	4
56.	Discriminator result (enumerated type)	-	sl	4	4
57.	SARin Discriminator Parameter 1=total power	1/1e15	sl	4	4
58.	SARin Discriminator Parameter 2=max Power	1/1e15	sl	4	4
59.	SARin Discriminator Parameter 3=mean Power	1/1e15	sl	4	4
60.	SARin Discriminator Par 4=bin of max power	1/1000	sl	4	4
61.	SARin Discriminator Par5=bin of half max pwr	1/1000	sl	4	4
62.	SARin Discriminator Par 6=max Coherence	1/1000	sl	4	4
63.	SARin Discriminator Par 7=bin max Coherence	1/1000	sl	4	4



Advanced Computer Systems



Instrument Processing Facility L2

Doc. No.: CS-RS-ACS-GS-5123
 Issue: 2.1
 Date: 18 February 2008
 Page: 54

64.	SARin Discriminator Par 8=first power bin	1/1000	sl	4	4
65.	SARin Discriminator Par 9=last power bin	1/1000	sl	4	4
66.	SARin Discriminator Parameter 10 - reserved	tbd	sl	4	4
67.	Discriminator status flag	-	ul	4	4
68.	Slope model correction attitude	μ deg	sl	4	4
69.	Slope model correction azimuth	μ deg	sl	4	4
70.	Uncorrected Latitude	10^{-1} μ -degree (see note 1)	sl	4	4
71.	Uncorrected Longitude	10^{-1} μ -degree (see note 1)	sl	4	4
72.	Ambiguity indicator	-	ul	4	4
73.	MSS from model	mm	sl	4	4
74.	Geoid from standard model	mm	sl	4	4
75.	DEM elevation (interpolated)	mm	sl	4	4
76.	DEM identifier (used in SARin)	-	ul	4	4
77.	Auxiliary Spares	-	uc	16x1	16
				Sub-total size	108
External Corrections group					
78.	Dry Tropospheric Correction	mm	sl	4	4
79.	Wet Tropospheric Correction	mm	sl	4	4
80.	Inverse Barometric Correction	mm	sl	4	4
81.	DORIS Ionospheric Correction	mm	sl	4	4
82.	Model Ionospheric Correction	mm	sl	4	4
83.	Ocean Tide	mm	sl	4	4
84.	Long-period equilibrium Ocean Tide	mm	sl	4	4
85.	Ocean Loading Tide	mm	sl	4	4
86.	Solid Earth Tide	mm	sl	4	4
87.	Geocentric Polar Tide	mm	sl	4	4
88.	Surface type flag	-	ul	4	4
89.	Correction status flags	-	ul	4	4
90.	Correction error flags	-	ul	4	4
91.	Sea State Bias (EM Bias)	mm	sl	4	4
92.	Spare		uc	8x1	8
				Sub-total size	64
Internal Corrections group					
93.	Doppler range correction (inc slope)	mm	sl	4	4
94.	Instrument Range Correction, t-r antenna	mm	sl	4	4
95.	Instrument Range Correction, r only antenna	mm	sl	4	4
96.	Instrument Sigma 0 correction, t-r antenna	dB/100	sl	4	4

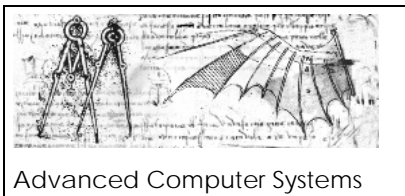

		(see note 2)			
97.	Instrument Sigma 0 correction, r only antenna	dB/100 (see note 2)	sl	4	4
98.	Internal Phase Correction	milli-radians	sl	4	4
99.	External Phase Correction	milli-radians	sl	4	4
100.	Noise power measurement	dB/100 (see note 2)	sl	4	4
101.	Spare		uc	12x1	12
Sub-total Size					44
Total Record Size					544

- 1) 10^{-1} μ degree is an exotic unit exclusively used at binary record level to improve resolution of the lat and long fields
- 2) 10^{-2} dB is an exotic unit used for db-units related fields.

Table 2.3.3.2-1 Interim L2 MDS

- Field 1)** MDSR Time Stamp - corresponding to the time the satellite is overhead of the centre of the measurement footprint, which is at the location given by Latitude and Longitude in [field 70](#) & [field 71](#).
- Field 2)** USO Correction factor - this is the correction factor for USO drift. It is defined as the ration between the nominal and the measured frequency.
- Field 3)** Mode ID - Identifies the SIRAL instrument measurement mode. see table 2.3.3.2-2

Definition	PDS Bit	SS Bit	Setting
Instrument mode - derived from configuration bits in the L0	15-10	0-5	000001 = 1 = LRM 000010 = 2 = SAR 000011 = 3 = SARin 001011 = 11 = CAL1-LRM 001100 = 12 = CAL1-SAR 001101 = 13 = CAL1-SARin 010110 = 22 = CAL2-SAR 010111 = 23 = CAL2-SARin
SARin degraded case	9	6	set to 1 if one receive chain is missing
Reserved	8	7	set to 0
CAL4 Mode	7	8	set to 1 for CAL4 packets

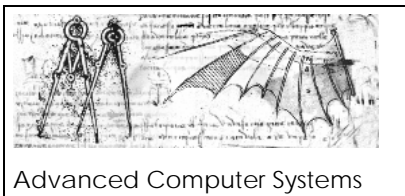

Platform attitude control	6-5	9-10	00 = unknown 01 = Local Normal Pointing mode (affirmed) 10 = Yaw Steering mode (affirmed)
Reserved	4-0	11-15	set to 0

Table 2.3.3.2-2 Mode ID

Field 4) Source Sequence Counter - passed through from the L1b record. Originally read from the L0 Echo telemetry packet (of the master channel in the case of SARin). This is a 16384 cyclic modulo counter, starting from 0, incrementing by 1. A separate counter is maintained for each instrument mode.

Field 5) Instrument Config flag - (ul giving 31 bits) This is derived from flags in the L0 packets for tracking and the echo. see table 2.3.3.2-3.

Definition	PDS Bit	SS Bit	Setting
Reception_chain_to_use	31-30	0-1	00 = 0 = unknown 01 = 1 = chain 1 10 = 2 = chain 2 11 = 3 = both
SIRAL_Identifier	29	2	0 = Nominal 1 = Redundant
Reserved	28	3	set to 0
Bandwidth	27-26	4-5	00 = unknown 01 = 320MHz 10 = 40 MHz
Reserved	25	6	set to 0
Reserved	24	7	set to 0
Tracking_mode	23-22	8-9	00 = 0 = unknown 01 = 1 = LRM 10 = 2 = SAR 11 = 3 = SARin
External Calibration	21	10	0 = no, 1 = External calibration
Reserved	20	11	set to 0
Loop_status	19	12	0 = closed loop 1 = open loop
Loss of echo (from cycle report)	18	13	0= OK, 1 = loss of echo
Real-time error (from cycle report)	17	14	0= OK, 1 = real time computation error (computing cycle too long)

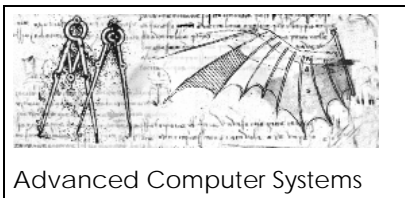

Echo saturation error (from cycle report)	16	15	0= OK, 1 = echo saturation detected
Reception_Band_Attenuation	15	16	0 = not attenuated 1 = attenuated
Cycle Report General Error	14	17	0 = cycle report is 0 1 = cycle report is not 0
Star Tracker 1 used	13	18	Set to 1 if Star Tracker 1 is used
Star Tracker 2 used	12	19	Set to 1 if Star Tracker 2 is used
Star Tracker 3 used	11	20	Set to 1 if Star Tracker 3 is used
Reserved	10-0	21-31	set to 0

Table 2.3.3.2-3 Instrument Configuration Flag

- Field 6)** Record counter - will increment from 1 for each record in the L2 product.
- Field 7)** Latitude of measurement - Corrected for off-nadir position of the retracked point; in SARin by using the inferred x-track angle and in LRM using slope models. The L1b Latitude (at Nadir) is preserved in **field** Units are 10^{-1} μ degrees.
- Field 8)** Longitude of measurement - (as for Latitude). Longitude (at Nadir) is preserved in **field**
- Field 9)** Altitude - Altitude of the Satellite CoG above reference ellipsoid at Nadir. This is not modified by SARin or LRM processing.
- Field 10)** Altitude rate - instantaneous rate of change of Altitude with time (from L1b)
- Field 11)** Satellite velocity vector -described in the International Terrestrial Reference Frame in the International Earth Fixed System. This is not a unit vector as the velocity magnitude is also required.
- Field 12)** Real beam direction vector - described in the CryoSat Reference Frame This is a unit vector and note that the units are micro-metres.
- Field 13)** Interferometric baseline vector - described in the Cryosat Reference Frame. This is a unit vector and note that the units are micro-metres.



Advanced Computer Systems



Instrument Processing Facility L2

Doc. No.: CS-RS-ACS-GS-5123
 Issue: 2.1
 Date: 18 February 2008
 Page: 58

Field 14) L2 MCD - Measurement confidence flags. See table 2.3.3.2-4. Generally the MCD flags indicate problems when set. If the whole MCD is 0 then no problems or non-nominal conditions were detected. Serious errors (highlighted in the table) are indicated by setting bit 31 (SS bit 0). In which case the block must not be processed. Other error settings can be regarded as warnings.

Definition	PDS Bit	SS Bit	Setting
Block degraded	31	0	0= OK, 1= Degraded (set if the block should not be processed – indicated by bold typeface & shading)
Blank Block	30	1	0 = OK 1 = Blank Block inserted for record padding
Datation Degraded	29	2	0 = OK 1 = Datation is bad or not set
Orbit propagation error	28	3	0= OK, 1= error (returned by CFI or by independent check)
Orbit file change	27	4	0= OK, 1= Orbit file has changed w.r.t. previous record
Orbit discontinuity	26	5	0= OK, 1= discontinuity (eg gap)
Echo Saturation -from L0	25	6	0= OK, 1= saturated (from echo saturation flag in the telemetry)
Other Echo error (e.g. empty waveform)	24	7	0= OK, 1= echo error
Receive Ch1 error for SARin	23	8	0= OK, 1= degraded or missing
Receive Ch2 error for SARin	22	9	0= OK, 1= degraded or missing
Window Delay Inconsistency	21	10	0 = OK (value is in range) 1 = value out of range or computation error
AGC Inconsistency	20	11	0 = OK (value is in range) 1 = value out of range or computation error
CAL 1 Correction Missing	19	12	0= OK, 1= missing - not applied
CAL1 from IPF DB used	18	13	0= default not used 1= default from IPF DB used
DORIS USO correction missing	17	14	0= OK, correction available 1= correction factor not available
Complex Cal1 from IPF DB used	16	15	0= default not used 1= default from IPF DB used
TRK Echo Error	15	16	0= OK, 1= degraded tracking echo
Echo Rx1 Error	14	17	0= OK, 1= bad raw echo
Echo Rx2 Error	13	18	0= OK, 1= bad raw echo

NPM Inconsistency	12	19	0= OK, 1= degraded, Value out of range or computation error
Azimuth Calibration Missing	11	20	0= OK, Azimuth calibration applied 1= No Azimuth calibration
Azimuth Calibration from IPF DB	10	21	0= default not used 1= default from IPF DB used
Range window calibration function Missing	9	22	0= OK, calibrated 1= No Calibration applied.
Range window calibration function from IPF DB	8	23	0= default not used 1= default from IPF DB used
Reserved	7	24	set to 0
CAL 2 Correction Missing	6	25	0= OK, 1= missing - not applied
CAL 2 from IPF DB used	5	26	0= default not used 1= default from IPF DB used
Power scaling error	4	27	0= OK, 1= Error in power scaling
Attitude Correction Missing	3	28	0= OK, Attitude correction applied 1= Not corrected
Attitude Interpolation Error	2	29	0 = OK 1 = Interpolation Error, attitude is wrong
Reserved	1	30	set to 0
Reserved	0	31	set to 0

Table 2.3.3.2-4 MCD Flag

Field 15) Height of surface : At measurement point w.r.t. the reference ellipsoid.

Field 16) Sigma 0 : fully corrected including instrument gain corrections and retracker correction.

Field 17) spare : reserved for future use

Field 18) Peakiness : of the echo in the L1b product. Note that this will require different interpretation for SAR and SARin echoes which are not the 'usual' pulse-limited echo shape.

Field 19) Retracked range correction : the offset of the retracked point on the echo from the reference point of the range window. This is a 1-way correction in mm.

Field 20) Retracked Sigma 0 correction : correction to Sigma0 resulting from the actual echo power being different from the nominal, or expected, echo power.

Field 21) Retracker output 3 : for other retracker algorithm output parameters



LRM = amplitude estimate P_u [femto watts]

SARin= Power in femto watts

SAR = unused =0

Field 22) Retracker output 4 : for other retracker algorithm output parameters

LRM = leading edge width (sigma c) [mBin]

SARin= echo width

SAR = unused =0

Field 23) Retracker output 5 : reserved for other retracker algorithm output parameters

LRM = initialisation value (retracked range corr from ocog) [mm]

SARin= Retracked bin

SAR = unused =0

Field 24) Retracker output 6 : reserved for other retracker algorithm output parameters

LRM = reserved for U10 tbc

SARin= tail slope $fw * bin^{n.5}$

SAR = unused =0

Field 25) Retracker output 7 : reserved for other retracker algorithm output parameters

LRM = reserved for SSB tbc.

SARin= tail delay [1/mBin]

SAR = unused =0

Field 26)Retracker output 8 : reserved for other retracker algorithm output parameters

LRM = unused = 0

SARin= Leading edge slope [1/1000]

SAR = unused =0

Field 27) Retracker output 9 : reserved for other retracker algorithm output parameters

LRM = unused = 0

SARin= χ^2 [1e6]

SAR = unused =0

Field 28) Retracker output 10 : reserved for other retracker algorithm output parameters

LRM = unused = 0

SARin= minimum χ^2 [1e6]

SAR = unused =0

Field 29) Retracker output 11 : reserved for other retracker algorithm output parameters

LRM = unused = 0

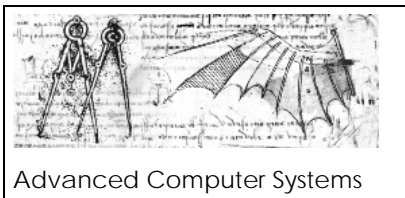

SARin= Phi Const (phase fit constant) [μ rad]
 SAR = unused =0

Field 30) Retracker output 12 : reserved for other retracker algorithm output parameters
 LRM = unused = 0
 SARin= Phi Slope (phase fit slope) [μ rad/bin]
 SAR = unused =0

Field 31) Retracker output 13 : reserved for other retracker algorithm output parameters
 LRM = Retracked point [mBin]
 SARin= retracked range [mm] note - not the correction
 SAR = Retracked point [mBin]

Field 32) Power echo shape parameter : TBD

Field 33) Beam Behaviour parameter - an array of 50 integers to characterise the shape of the set of Doppler echoes from a common surface location prior to stacking (averaging). Currently the first 5 numbers are defined as follows, while the remainder are reserved for future use. See table 2.3.3.2-5.

Index	Name	Description
[0]	STACK_HALF_WIDTH	standard deviation [type=us]
[1]	STACK_CENTRE	Beam in stack at maximum of the fitted Gaussian [type=us]
[2]	STACK_AMPLITUDE	Stack scaled amplitude [type=us]
[3]	STACK_SKEWNESS	Stack skewness [type=ss] val/100, -99900 (TBD) if cannot be computed
[4]	STACK_KURTOSIS	Stack kurtosis [type=ss] val/100, -99900 (TBD) if cannot be computed
[5-49]	Spare elementes	Reserved for future use

Table 2.3.3.2-5 Beam Behaviour

Field 34) x-Track Angle : from the interferometric processing in SARin mode. This is the inferred cross-track angle corresponding to the Retrack point of the SARin echo. This can be used in combination with the Altitude to derive a horizontal offset from Nadir. The Latitude and Longitude in **field** and **field** include this offset. Set to zero for SAR and LRM.

Field 35) Coherence : derived from the SARin echoes at the Retrack point, this provides a measure of confidence in the interferometric result. Set to 0 for SAR and LRM modes.

Field 36) Interpolated Ocean Height (or MSS) : the ocean height interpolated from the SAR measurement data, which is used in conjunction with surface height (**field**) to compute a

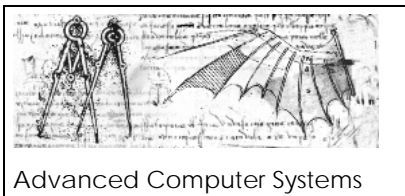

freeboard.

- Field 37)** Freeboard : SAR mode computed freeboard of the Sea Ice. Initially (e.g. for launch plus 1 year) this will be set to zero, when there is greater confidence in the knowledge of the Arctic basin sea surface height then freeboard will be computed in the L2 products. Set to 0 in SARin and LRM modes.
- Field 38)** Surface Height Anomaly : difference between the measured sea surface height and the MSS from the model.
- Field 39)** Interpolated Sea Surface Height Anomaly : difference between the interpolated sea surface height and the MSS from the model.
- Field 40)** Interpolation error for Ocean Height : height error in mm associated with the interpolated Ocean Height.
- Field 41)** Number of interpolation points used -forward : the number of measurement points in front of current record that were used to interpolate the Ocean Height to this record.
- Field 42)** Number of interpolation points used -backward : the number of measurement points behind current record that were used to interpolate the Ocean Height to this record.
- Field 43)** Radius of interpolation -forward (in time) : maximum distance, in front of current location, of points used to interpolate the Ocean Height to this record. Units are in time (ms) which can be converted to km by multiplying by the satellite ground-speed.
- Field 44)** Radius of interpolation -backward (in time) : maximum distance, behind current location, of points used to interpolate the Ocean Height to this record. Units are in time (ms) which can be converted to km by multiplying by the satellite ground-speed.
- Field 45)** Interpolation error flag : Indicates errors in ocean height interpolation.
- Field 46)** Measurement mode (LRM / SAR / SARin) : LRM=1, SAR=2, SARin=3
- Field 47)** Measurement Quality Flags : Used to indicate errors with any component parameters in this group. See table 2.3.3.2-6.

Definition	PDS Bit	SS Bit	Setting
Height error	31	0	0 = no, 1 = yes
Sigma0 error	30	1	0 = no, 1 = yes

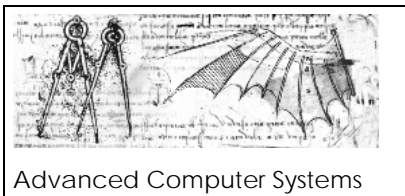

SWH or Slope error	29	2	0 = no, 1 = yes
Peakiness error	28	3	0 = no, 1 = yes
Echo shape error	27	4	0 = no, 1 = yes
x-track angle error	26	5	0 = no, 1 = ambiguous angle
Coherence error	25	6	0 = no, 1 = yes
Unused	24-0	7-31	set to 0

Table 2.3.3.2-6 Measurement Quality Flag

Field 48) Retracker Flags : Indicate errors from the retracker algorithms in each mode. See table 2.3.3.2-7.

Definition	PDS Bit	SS Bit	Setting
Overall retracker failure flag	31	0	0 = no, 1 = yes
Low or zero power in waveform flag	30	1	0 = no, 1 = yes
Low peakiness flag	29	2	0 = no, 1 = yes
High peakiness flag	28	3	0 = no, 1 = yes
High noise flag	27	4	0 = no, 1 = yes
Low variance flag	26	5	0 = no, 1 = yes
Bad leading edge flag	25	6	0 = no, 1 = yes
Retrack position out of range	24	7	0 = no, 1 = yes
Abnormal beam behaviour parameters	23	8	0 = no, 1 = yes
Bad backscatter calculation	22	9	0 = no, 1 = yes
Reserved SWH	21	10	0 = no, 1 = yes
Reserved U10	20	11	0 = no, 1 = yes
Reserved SSB	19	12	0 = no, 1 = yes
Spare 4	18	13	0 = no, 1 = yes
SARin Retracker interpolation failure flag	17	14	0 = no, 1 = yes
SARin low coherence flag	16	15	0 = no, 1 = yes
Spare 6	15	16	0 = no, 1 = yes
Spare 7	14	17	0 = no, 1 = yes
Spare 8	13	18	0 = no, 1 = yes
Spare 9	12	19	0 = no, 1 = yes
Spare 10	11	20	0 = no, 1 = yes
Spare 11	10	21	0 = no, 1 = yes
SAR spare 12	9	22	0 = no, 1 = yes
SAR spare 13	8	23	0 = no, 1 = yes
SAR spare 14	7	24	0 = no, 1 = yes

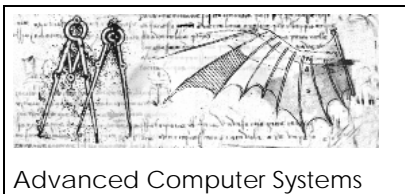

SAR spare 15	6	25	0 = no, 1 = yes
SAR spare 16	5	26	0 = no, 1 = yes
SAR spare 17	4	27	0 = no, 1 = yes
SAR spare 18	3	28	0 = no, 1 = yes
SAR spare 19	2	29	0 = no, 1 = yes
LRM Retracker was CFI Ocean	1	30	0 = no, 1 = yes
LRM Retracker was OCOG	0	31	0 = no, 1 = yes

Table 2.3.3.2-7 Retracker Flag

Field 49) Height Status Flags : Shows if corrections have been applied to the height field 15. See table 2.3.3.2-8.

Definition	PDS Bit	SS Bit	Setting
Corrected for internal calibration	31	0	0 = no, 1 = yes
Corrected for Radial Doppler	30	1	0 = no, 1 = yes
Corrected for Dry Tropo	29	2	0 = no, 1 = yes
Corrected for Wet Tropo	28	3	0 = no, 1 = yes
Corrected for Inverse Barometer	27	4	0 = no, 1 = yes
Corrected for Ionosphere - DORIS	26	5	0 = no, 1 = yes
Corrected for Ionosphere - Model	25	6	0 = no, 1 = yes
Ocean tide 1 used	24	7	0 = no, 1 = yes
Ocean tide 2 used	23	8	0 = no, 1 = yes
Ocean loading tide used	22	9	0 = no, 1 = yes
Solid earth tide used	21	10	0 = no, 1 = yes
Geocentric Polar tide used	20	11	0 = no, 1 = yes
Slope Doppler corrected	19	12	0 = no, 1 = yes
Mode specific window offset applied	18	13	0 = no, 1 = yes
SAR retracker applied	17	14	0 = no, 1 = yes
SARin retracker applied	16	15	0 = no, 1 = yes
LRM retracker applied	15	16	0 = no, 1 = yes
LRM Ocean bias applied	14	17	0 = no, 1 = yes
LRM Ice bias applied	13	18	0 = no, 1 = yes
SAR Ocean bias applied	12	19	0 = no, 1 = yes
SAR Ice bias applied	11	20	0 = no, 1 = yes
SARin Ocean bias applied	10	21	0 = no, 1 = yes
SARin Ice bias applied	9	22	0 = no, 1 = yes
LRM Slope model data valid	8	23	0 = no, 1 = yes
SARin baseline downward flag	7	24	0 = no, 1 = yes

SARin baseline forward flag	6	25	0 = no, 1 = yes
SARin out of range flag	5	26	0 = no, 1 = yes
Unused	4 - 0	27-31	set to 0

Table 2.3.3.2-8 Height Status Flag

Field 50) SAR Freeboard Status Flags : flags to indicate availability and reliability of the freeboard measurement. See table 2.3.3.2-9.

Definition	PDS Bit	SS Bit	Setting
Freeboard measurement unavailable	31	0	0 = no, 1 = yes
Freeboard measurement unreliable	30	1	0 = no, 1 = yes
Freeboard measurement is in northern geographical boundary	29	2	0 = no, 1 = yes
Freeboard measurement is in southern geographical boundary	28	3	0 = no, 1 = yes
spare – tbd	27 - 0	4 - 31	set to 0

Table 2.3.3.2-9 SAR Freeboard Status Flag

Field 51) Number of Echoes/beams averaged : In LRM mode this is the number of echoes which have been averaged to make 1 measurement (normally). In SAR and SARin mode it is the number of Doppler beams which have been stacked to derive each measurement. Near the beginning and end of each section of SAR or SARin mode operation this number will reduce below the nominal value and there is a corresponding decrease in the signal to noise ratio of the waveform.

Field 52) Spare : reserved for wind speed.

Field 53) Measurement Spares : reserved for possible future use

Field 54) Ice concentration parameter : a percentage estimate of Sea Ice concentration merged from model data.

Field 55) Snow Depth : in mm merged from a climatology model data. This can be used (by L2 product User) to adjust the freeboard estimate.

Field 56) Discriminator result : enumerated type code showing the result of the discriminator algorithm

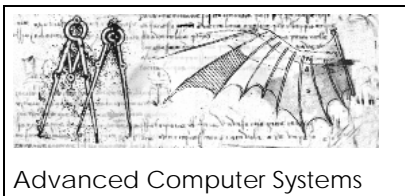

in each chain. See table 2.3.3.2-10.

Value	Definition
1	Result of LRM discrimination is undefined
2	Result of LRM discrimination is ocean
3	Result of LRM discrimination is land ice plateau
101	Result of SARIN discrimination is undefined
102	Result of SARIN discrimination is altimeter mode
201	Result of SAR discrimination is undefined.
202	Result of SAR discrimination is ocean.
203	Result of SAR discrimination is Sea Ice.
204	Result of SAR discrimination is Leads.

Table 2.3.3.2-10 Discriminator Results

- Field 57) SARin Discriminator Parameter 1 : total Power [1e-15]
- Field 58) SARin Discriminator Parameter 2 : max Power [1e-15]
- Field 59) SARin Discriminator Parameter 3 : mean Power [1e-15]
- Field 60) SARin Discriminator Parameter 4 : bin with max power [1/1000]
- Field 61) SARin Discriminator Parameter 5 : bin of half max power [1/1000]
- Field 62) SARin Discriminator Parameter 6 : max Coherence [1/1000]
- Field 63) SARin Discriminator Parameter 7 : bin with max Coherence [1/1000]
- Field 64) SARin Discriminator Parameter 8 : first power bin [1/1000]
- Field 65) SARin Discriminator Parameter 9 : last power bin [1/1000]
- Field 66) SARin Discriminator Parameter 10 : =0, reserved for tbd [1/1000]
- Field 67) Discriminator status flag : shows quality of the discriminator result for each chain. See table 2.3.3.2-11.

Definition	PDS	SS Bit	Setting
------------	-----	--------	---------

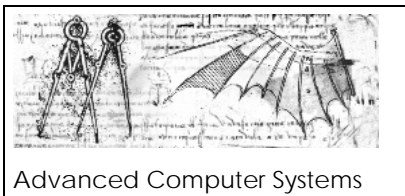

	Bit		
Overall discriminator failure flag	31	0	0 = no, 1 = yes
LRM discriminator flags TBD	30	1	0 = no, 1 = yes
TBD - reserved for LRM	29-22	2-9	set to 0
SARin Low Variance flag	21	10	0 = no, 1 = yes
SARin Bad Leading Edge flag	20	11	0 = no, 1 = yes
SARin High Noise flag	19	12	0 = no, 1 = yes
SARin Low Peakiness flag	18	13	0 = no, 1 = yes
SARin Hi Peakiness flag	17	14	0 = no, 1 = yes
SARin Low Power flag	16	15	0 = no, 1 = yes
TBD - reserved for SARin	15-12	16-19	set to 0
SAR very high peakiness flag	11	20	0 = no, 1 = yes
SAR very low peakiness flag	10	21	0 = no, 1 = yes
SAR Low or zero power flag	9	22	0 = no, 1 = yes
SAR abnormal beam behaviour parameters	8	23	0 = no, 1 = yes
SAR ice concentration unavailable	7	24	0 = no, 1 = yes
SAR ice concentration unreliable	6	25	0 = no, 1 = yes
SAR signal to noise ratio too low	5	26	0 = no, 1 = yes
Waveform is too wide	4	27	0 = no, 1 = yes
No votes for any available waveform classification	3	28	0 = no, 1 = yes
Voting for discrimination classification tied	2	29	0 = no, 1 = yes
TBD	1	30	set to 0
SAR partial match	0	31	0 = no, 1 = yes

Table 2.3.3.2-11 Discriminator Status Flag

Field 68) Slope model correction attitude : attitude angle of nearest echoing point on surface as determined from slope models in LRM processing. 0 if model not present or invalid. Set to 0 for SAR and SARin but may be used in the event of SARin mode with only 1 receive chain operating.

Field 69) Slope model correction azimuth : as for attitude

Field 70) Uncorrected Latitude : of the Nadir position - this allows for removal of the slope corrected position if desired.

Field 71) Uncorrected Longitude : of the Nadir position - this allows for removal of the slope corrected position if desired.

Field 72) Ambiguity indicator : to flag the case where the interferometric angle may be ambiguous due to phase wrapping. See table 2.3.3.2-12.

Definition	PDS Bit	SS Bit	Setting
Overall Ambiguity	31	0	0 = no, 1 = yes
TBD Ambiguity	30	1	0 = no, 1 = yes
Unused	29-22	2-9	set to 0
DEM <u>not</u> available	21	10	0 = no, 1 = yes
Different elevations	20	11	0 = no, 1 = yes
Unused	19-0	12-31	set to 0

Table 2.3.3.2-12 SARIN Ambiguity Indicator Flags

Field 73) MSS from model : from the ocean model.

Field 74) Geoid from standard model : from the Geoid model.

Field 75) DEM elevation : interpolated from a DEM (model tbd) to act as a check against the SARin derived elevation. Set in SARin mode only, =0 for LRM & SAR.

Field 76) DEM identifier : to identify the DEM model used in SARin

Field 77) Auxiliary Spares : reserved for possible future use

Field 78) Dry Tropospheric Correction - to be added to range measurement to correct for the propagation delay to the radar pulse, caused by the dry-gas component of the Earth's atmosphere.

Field 79) Wet Tropospheric Correction - to be added to range measurement to correct for the propagation delay to the radar pulse, caused by the H2O component of the Earth's atmosphere.

Field 80) Inverse Barometric Correction - to be added to range measurement to correct for the depression of the ocean surface caused by the local barometric pressure.

Field 81) DORIS Ionospheric Correction - to be added to range measurement to correct for the delay to the Radar pulse caused by free electrons in the ionosphere. Computed from the concurrent DORIS data.

Field 82) Model Ionospheric Correction - to be added to range measurement to correct for the delay to the Radar pulse caused by free electrons in the ionosphere. Computed from an Ionospheric



Advanced Computer Systems



Instrument Processing Facility L2

Doc. No.: *CS-RS-ACS-GS-5123*
Issue: *2.1*
Date: *18 February 2008*
Page: *69*

model.

- Field 83)** Ocean Tide - (component of total ocean tide) to be added to the range to remove the effect of local tide and adjust the measurement to the mean sea surface.
- Field 84)** Long-Period equilibrium Ocean Tide - (component of total ocean tide) to be added to the range to remove the effect of local tide and adjust the measurement to the mean sea surface.
- Field 85)** Ocean Loading Tide - to be added to the range to remove the effect of local tidal distortion to the Earth's crust.
- Field 86)** Solid Earth Tide - added to the range to remove the effect of local tidal distortion in the Earth's crust.
- Field 87)** Geocentric Polar Tide - to be added to the range to remove a long-period distortion of the Earth's crust. Although called a 'tide' this is in fact caused by variations in centrifugal force as the Earth's rotational axis moves its geographic location.
- Field 88)** Surface type flag - enumerated key to classify surface at nadir provided by a model. Note this flag is distinct from the surface discrimination in the SAR processing. See Table 2.3.3.1-3
- Field 89)** Correction status flag - used to show which correction algorithms have been called, see . First 11 fields are as in L1b. See table 2.3.3.2-13.

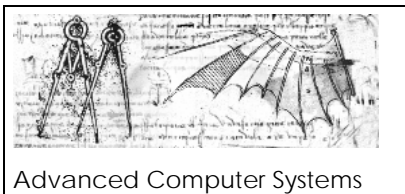

Advanced Computer Systems



Instrument Processing Facility L2

Doc. No.: CS-RS-ACS-GS-5123
 Issue: 2.1
 Date: 18 February 2008
 Page: 70

Definition	PDS Bit	SS Bit	Setting
Dry Tropospheric Correction Called	31	0	0 = no, 1 = yes
Wet Tropospheric Correction Called	30	1	0 = no, 1 = yes
Inverse Barometric Correction Called	29	2	0 = no, 1 = yes
DORIS Ionospheric Correction Called	28	3	0 = no, 1 = yes
Model Ionospheric Correction Called	27	4	0 = no, 1 = yes
Ocean Tide Called	26	5	0 = no, 1 = yes
Long-period equilibrium Ocean Tide Called	25	6	0 = no, 1 = yes
Ocean Loading Tide Called	24	7	0 = no, 1 = yes
Solid Earth Tide Called	23	8	0 = no, 1 = yes
Geocentric Polar Tide Called	22	9	0 = no, 1 = yes
Surface type flag Called	21	10	0 = no, 1 = yes
Ice concentration model called	20	11	0 = no, 1 = yes
Snow depth model Called	19	12	0 = no, 1 = yes
MSS model called	18	13	0 = no, 1 = yes
Geoid model Called	17	14	0 = no, 1 = yes
DEM model called	16	15	0 = no, 1 = yes
Slope model Called	15	16	0 = no, 1 = yes
Reserved	14-0	17-31	set to 0

Table 2.3.3.2-13 Corrections Status Flags

Field 90) Correction error flag - used to show if a correction algorithms returned an error when called see table 2.3.3.2-14. First 11 fields are as in L1b.

Definition	PDS Bit	SS Bit	Setting
Dry Tropospheric Correction Error	31	0	0 = OK, 1 = error
Wet Tropospheric Correction Error	30	1	0 = OK, 1 = error
Inverse Barometric Correction Error	29	2	0 = OK, 1 = error
DORIS Ionospheric Correction Error	28	3	0 = OK, 1 = error
Model Ionospheric Correction Error	27	4	0 = OK, 1 = error
Ocean Tide Error	26	5	0 = OK, 1 = error
Long-period equilibrium Ocean Tide Error	25	6	0 = OK, 1 = error
Ocean Loading Tide Error	24	7	0 = OK, 1 = error
Solid Earth Tide Error	23	8	0 = OK, 1 = error

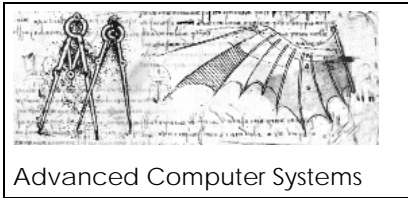

Geocentric Polar Tide Error	22	9	0 = OK, 1 = error
Surface type flag Error	21	10	0 = OK, 1 = error
Ice concentration Error	20	11	0 = OK, 1 = error
Snow depth Error	19	12	0 = OK, 1 = error
MSS model Error	18	13	0 = OK, 1 = error
Geoid model Error	17	14	0 = OK, 1 = error
DEM model Error	16	15	0 = OK, 1 = error
Slope model Error	15	16	0 = OK, 1 = error
Reserved	14-0	17-31	set to 0

Table 2.3.3.2-14 Corrections Error Flags

 <p>Advanced Computer Systems</p>		<p><i>Instrument Processing Facility L2</i></p> <p>Doc. No.: <i>CS-RS-ACS-GS-5123</i> Issue: <i>2.1</i> Date: <i>18 February 2008</i> Page: <i>72</i></p>
---	---	--

Field 91) Sea State Bias correction - (a.k.a. EM bias correction) An empirical correction proportional to the significant wave height which compensates for the asymmetric shape of ocean waves .

Field 92) Correction spares - reserved for future use.

Field 93) Doppler range correction - computed from the line of sight vector and thus includes slope model component where slope model is used.

Field 94) Instrument Range Correction (Tx-Rx chain) - Calibration correction to range on channel 1 computed from CAL1. (CAL1-LRM, CAL1-SAR and CAL1-SARin)

Field 95) Instrument Range Correction (Rx only chain) - Calibration correction to range on channel 2 computed from CAL1. (CAL1-LRM, CAL1-SAR and CAL1-SARin)

Field 96) Instrument Gain Correction (t-r chain) - Calibration correction to gain on channel 1 computed from CAL1. (Sometimes referred to as 'Sigma0 correction')

Field 97) Instrument Gain Correction (r only chain) - Calibration correction to gain on channel 2 computed from CAL1.

Field 98) Internal phase correction. - reserved for future use

Field 99) External phase correction. - reserved for future use

Field 100) Noise power measurement - converted from telemetry units to be the noise floor of FBR measurement echoes

Field 101) reserved spares

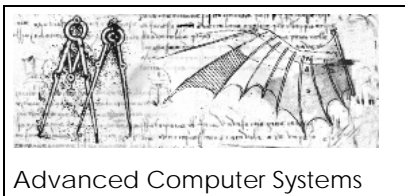

3 FAST DELIVERY OCEAN L2 DATA PRODUCTS

A special Level-2 chain has been designed to produce a Fast Delivery Ocean (FDO) product for the benefit of Metrologists and oceanographers. This product is produced for LRM mode data only and is run as soon as possibly after acquisition using the DORIS Navigator orbit. The frequency of FD data records is approximately 1 /second.

The FDO Measurement Dataset has a single format as it is only ever produced from SIRAL LRM data.

Product parameters are grouped according to function into 5 logical sub-structures as follows:

Location Group time and orbit location

Range Group Range and retracker results

Range Corrections Group derived from auxiliary data or models

SWH and Backscatter Group parameters relating to SWH and sigma0

Geophysical Group MSS, Geoid, Tides etc from external models

The record structure is illustrated in the following diagram and exclusively applies to SIR_FDM_2_ product type. The repetition frequency of each sub- structure is 1, therefore the groupings are conceptual rather than physical.

Repetition of sub-structure				
x1	x1	x1	x1	x1
Time & Orbit Group	Range Group	Corrections Group	SWH & Backscatter	Geophysical Group



Advanced Computer Systems



Instrument Processing Facility L2

Doc. No.: CS-RS-ACS-GS-5123
 Issue: 2.1
 Date: 18 February 2008
 Page: 74

ID	Descriptor	Unit	Type 'C'	Size (bytes)	Tot. Size (bytes)
Time and orbit Group					
1.	Data Record Time (MDSR Time Stamp)	TAI	sl+2*ul	12	12
2.	20 Hz Time differences [0..19]	μ -secs	sl	20*4	80
3.	Latitude of measurement	10^{-1} μ -degree	sl	4	4
4.	20 Hz Latitude of measurement [0..19]	10^{-1} μ -degree	sl	20*4	80
5.	Longitude of measurement	10^{-1} μ -degree	sl	4	4
6.	20 Hz Longitude of measurement [0..19]	10^{-1} μ -degree	sl	20*4	80
7.	Record Counter	-	ul	4	4
8.	MCD	-	ul	4	4
9.	Altitude of COG above reference ellipsoid	mm	sl	4	4
10.	20 Hz Altitude of COG above reference ellipsoid [0..19]	mm	sl	20*4	80
11.	Instantaneous altitude rate derived from orbit	mm/sec	ss	2	2
12.	Spares	-	uc	2*1	2
Range Measurements Group					
13.	Range to Ocean surface	mm	ul	4	4
14.	20 Hz ocean range [0..19]	mm	ul	20*4	80
15.	Standard deviation of 20 Hz ocean range	mm	us	2	2
16.	Number of 20 Hz valid points for ocean range		us	2	2
17.	OCOg range	mm	ul	4	4
18.	20 Hz OCOg range [0..19]	mm	ul	20*4	80
19.	Standard deviation of 20 Hz OCOg range	mm	us	2	2
20.	Number of 20 Hz valid points for OCOg range		us	2	2
Corrections Group					
21.	Doppler correction	mm	ss	2	2
22.	Dry Tropospheric correction	mm	ss	2	2
23.	Model Wet Tropospheric correction	mm	ss	2	2
24.	Inverse Barometer correction	mm	ss	2	2
25.	Ionospheric correction	mm	ss	2	2
26.	Sea state bias correction (EM Bias)	mm	ss	2	2
27.	Spare (reserved for future use)	-	ss	2	2
28.	Spare (reserved for future use)	-	ss	2	2
SWH & Backscatter Group					
29.	Square of Significant wave height	mm ²	sl	4	4
30.	Significant wave height	mm	ss	2	2
31.	Spare		ss	2	2



Advanced Computer Systems



Instrument Processing Facility L2

Doc. No.: CS-RS-ACS-GS-5123
 Issue: 2.1
 Date: 18 February 2008
 Page: 75

32	20 Hz SWH-squared [0..19]	mm ²	sl	20*4	80
33	Standard deviation of 20 Hz SWH-squared	mm ²	ss	2	2
34	Number of 20 Hz valid points for SWH- squared	-	us	2	2
35	Spare	-	ss	2	2
36	Corrected ocean backscatter coefficient	dB/100	ss	2	2
37	20 Hz ocean backscatter coefficient [0..19]	dB/100	ss	20*2	40
38	Standard deviation of 20 Hz ocean backscatter coefficient	dB/100	ss	2	2
39	Number of 20 Hz valid points for ocean backscatter coefficient	-	us	2	2
40	Spare	-	ss	2	2
41	Corrected OCOG backscatter coefficient	dB/100	ss	2	2
42	20 Hz corrected OCOG backscatter coefficient [0..19]	dB/100	ss	20*2	40
43	Standard deviation of 20 Hz OCOG backscatter coefficient	dB/100	ss	2	2
44	Number of 20 Hz valid points for OCOG backscatter coefficient	-	us	2	2
45	off nadir angle of the satellite from platform data	deg/10 ⁴	sl	4	4
46	Spare - reserved for future use	-	sl	4	4
Geophysical Group					
47	Mean sea-surface height (MSS)	mm	sl	4	4
48	Geoid height	mm	sl	4	4
49	Ocean depth/land elevation (ODLE)	mm	sl	4	4
50	Total geocentric ocean tide height (solution 2)	mm	ss	2	2
51	Long period tide height	mm	ss	2	2
52	Tidal loading height (solution 2)	mm	ss	2	2
53	Solid earth tide height	mm	ss	2	2
54	Geocentric pole tide height	mm	ss	2	2
55	Altimeter wind speed	mm/s	ss	2	2
56	U-component of the model wind vector	mm/s	ss	2	2
57	V-component of the model wind vector	mm/s	ss	2	2
58	20 Hz ku-band peakiness [0..19]	-	us	20*2	
59	Ocean retracking quality [20bits]	flags	ul	4	4
60	Altimeter surface type flag	flags	us	2	2
61	Spare (reserved for Sea ice flag TBC)	flags	us	2	2
Total Size					820 Bytes

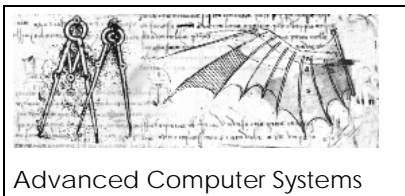

- Field 1)** MDSR Time Stamp - corresponding to satellite overhead location for the 1Hz measurement at position given by 1Hz Latitude and Longitude **field 3** & **field 5**
- Field 2)** 20 Hz time - to be added to Time Stamp to give time of each high-rate measurement
- Field 3)** Latitude at 1Hz - Corresponding to Nadir. Units are 10^{-1} μ degrees.
- Field 4)** Latitude at 20Hz - Corresponding to Nadir. Units are 10^{-1} μ degrees.
- Field 5)** Longitude at 1 Hz - Corresponding to Nadir. Units are 10^{-1} μ degrees.
- Field 6)** Longitude at 20 Hz - Corresponding to Nadir. Units are 10^{-1} μ degrees.
- Field 7)** Record counter - will increment from 1 for each record in the L2 product.
- Field 8)** L2 MCD - Measurement confidence flags. See Generally the MCD flags indicate problems when set. If the whole MCD is 0 then no problems or non-nominal conditions were detected. Serious errors (bold style in the table) are indicated by setting bit 31 (SS bit 0). In which case the block must not be processed. Other error settings can be regarded as warnings.

Definition	PDS Bit	SS Bit	Setting
Block degraded	31	0	0= OK, 1= degraded (set if the block should not be processed - conditions are indicated by bold typecharacter in this table)
Blank Block	30	1	0= OK, 1= Blank block inserted for record padding
Datation degraded	29	2	0= OK, 1= datation is bad or not set
Orbit propagation error	28	3	0= OK, 1= error (returned by CFI or by independent check)
Orbit file change	27	4	0= OK, 1= Orbit file has changed w.r.t. previous record
Orbit discontinuity	26	5	0= OK, 1= discontinuity (eg gap)
Echo Saturation -from L0	25	6	0= OK, 1= saturated (from echo saturation flag in the telemetry)
Other Echo error (e.g. empty waveform)	24	7	0= OK, 1= echo error (this is set if either EchoRx1/2 Error bits are set)
Receive Ch1 error for SARin	23	8	0= OK, 1= degraded or missing
Receive Ch2 error for SARin	22	9	0= OK, 1= degraded or missing
Window Delay Inconsistency	21	10	0= OK, 1= degraded, Value out of range or computation error

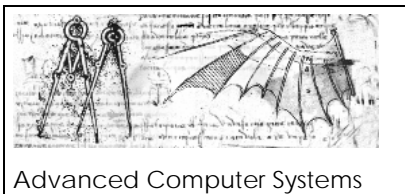

AGC Inconsistency	20	11	0= OK, 1= degraded, Value out of range or computation error
CAL 1 Correction Missing	19	12	0= OK, 1= missing - not applied
CAL1 from IPF DB used	18	13	0= default not used 1= default from IPF DB used
DORIS USO correction missing	17	14	0= OK, correction available 1= correction factor not available
Complex Cal1 from IPF DB used	16	15	0= default not used 1= default from IPF DB used
TRK Echo Error	15	16	0= OK, 1= degraded tracking echo
Echo Rx1 Error	14	17	0= OK, 1= bad raw echo
Echo Rx2 Error	13	18	0= OK, 1= bad raw echo
NPM Inconsistency	12	19	0= OK, 1= degraded, Value out of range or computation error
Azimuth Calibration Missing	11	20	0= OK, Azimuth calibration applied 1= No Azimuth calibration
Azimuth Calibration from IPF DB	10	21	0= default not used 1= default from IPF DB used
Range window calibration function Missing	9	22	0= OK, calibrated 1= No Calibration applied.
Range window calibration function from IPF DB	8	23	0= default not used 1= default from IPF DB used
Reserved	7	24	set to 0
CAL 2 Correction Missing	6	25	0= OK, 1= missing - not applied
CAL 2 from IPF DB used	5	26	0= default not used 1= default from IPF DB used
Power scaling error	4	27	0= OK, 1= Error in power scaling
Attitude Correction Missing	3	28	0= OK, Attitude correction applied 1= Not corrected
Attitude Interpolation Error	2	29	0 = OK 1 = Interpolation Error, attitude is wrong
Reserved	1	30	set to 0
Reserved	0	31	set to 0

Field 9) Altitude at 1 Hz- Altitude of the Satellite CoG above reference ellipsoid at Nadir.

Field 10) Altitude at 20 Hz- Altitude of the Satellite CoG above reference ellipsoid at Nadir.

Field 11) Altitude rate - instantaneous rate of change of Altitude with time (from L1b)

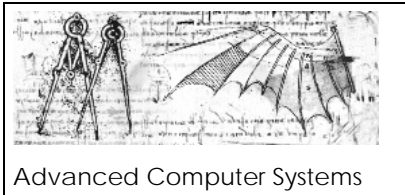

Field 12) Spares

Field 13) Ocean Range - retracked by the ocean retracker

Field 14) Ocean Range at 20 Hz - retracked by the ocean retracker

Field 15) Standard deviation of 20 Hz ocean range

Field 16) Number of 20 Hz valid points for ocean range measurement

Field 17) OCOG Range - retracked by the OCOG algorithm retracker

Field 18) OCOG Range at 20 Hz - retracked by the OCOG retracker

Field 19) Standard deviation of 20 Hz OCOG range

Field 20) Number of 20 Hz valid points for OCOG range measurement

Field 21) Doppler Correction to Range - caused by the Doppler shift in the line of sight to the Nadir direction. The correction has been applied in the range measurement.

Field 22) Dry Tropospheric Correction - to be added to range measurement to correct for the propagation delay to the radar pulse, caused by the dry-gas component of the Earth's atmosphere.

Field 23) Wet Tropospheric Correction - to be added to range measurement to correct for the propagation delay to the radar pulse, caused by the H₂O component of the Earth's atmosphere.

Field 24) Inverse Barometric Correction - to be added to range measurement to correct for the depression of the ocean surface caused by the local barometric pressure.

Field 25) Model Ionospheric Correction - to be added to range measurement to correct for the delay to the Radar pulse caused by free electrons in the ionosphere. Computed from the GIM Ionospheric model.

Field 26) Sea State Bias correction - (a.k.a. EM bias correction) An empirical correction proportional to the significant wave height which compensates for the asymmetric shape of ocean waves .

Field 27) spare - (reserved for possible high frequency barotropic correction)

Field 28) spare - (for byte alignment)



Advanced Computer Systems



Instrument Processing Facility L2

Doc. No.: *CS-RS-ACS-GS-5123*
Issue: *2.1*
Date: *18 February 2008*
Page: *79*

- Field 29)** square of the 1 Hz SWH - in mm^2 , NOTE that this can be a negative value so the User must take care if taking a square root (SWH² is derived from $\text{SigmaC}^2 - \text{PTR_width}^2$ which can be <0)
- Field 30)** SWH at 1 Hz
- Field 31)** spare - (for byte alignment)
- Field 32)** SWH squared at 20 Hz, as above,
- Field 33)** Standard deviation of SWH squared at 20 Hz
- Field 34)** Number of 20 Hz valid points for SWH squared
- Field 35)** spare - (for byte alignment)
- Field 36)** Corrected ocean backscatter coefficient (Sigma_0) - corrected for calibrations and Ocean retracker
- Field 37)** 20 Hz Corrected ocean backscatter coefficient (Sigma_0)
- Field 38)** Standard Deviation of 20 Hz Corrected ocean backscatter coefficient
- Field 39)** Number of valid points of 20 Hz Corrected ocean backscatter coefficient
- Field 40)** spare - (for byte alignment)
- Field 41)** Corrected OCOG backscatter coefficient (Sigma_0) - corrected for calibrations and OCOG retracker
- Field 42)** 20 Hz Corrected OCOG backscatter coefficient (Sigma_0)
- Field 43)** Standard Deviation of 20 Hz Corrected OCOG backscatter coefficient
- Field 44)** Number of valid points of 20 Hz Corrected OCOG backscatter coefficient
- Field 45)** Off Nadir angle from satellite data. - Derived from the Star Trackers.
- Field 46)** Spare - reserved for possible future use as Off Nadir angle from waveform data.
- Field 47)** Mean Sea Surface from CryoSat UCL04 model.



Advanced Computer Systems



Instrument Processing Facility L2

Doc. No.: *CS-RS-ACS-GS-5123*
Issue: *2.1*
Date: *18 February 2008*
Page: *80*

Field 48) Geoid from standard model.

Field 49) ODLE - Ocean Depth Elevation

Field 50) Total Geocentric Ocean Tide - to be added to the range to remove the effect of local ocean tide and adjust the measurement to the mean sea surface. This field includes the components given in **field** and **field**

Field 51) Long-Period equilibrium Ocean Tide - a component of total ocean tide already included in the value computed above **field** Sign of the correction is such that it is added to the range measurement.

Field 52) Ocean Loading Tide - to remove the effect of local distortion to the Earth's crust caused by increasing weight of ocean as local water tide rises. This component is already included in the total ocean tide value computed above **field** The sign is such that the correction is added to the range.

Field 53) Solid Earth Tide - to be added to the range to remove the effect of local tidal distortion in the Earth's crust.

Field 54) Geocentric Polar Tide - to be added to the range to remove a long-period distortion of the Earth's crust. Although called a 'tide' this is in fact caused by variations in centrifugal force as the Earth's rotational axis moves its geographic location.

Field 55) Altimeter Wind Speed computed from backscatter coefficient.

Field 56) U-component of the model Wind vector.

Field 57) V-component of the model Wind vector.

Field 58) Peakiness : of the echo in the L1b product. Units are 1/1000.

Field 59) Ocean retracking quality flag - using 20 bits to indicate OK/error.

Field 60) Surface type flag - enumerated key to classify surface at nadir provided by a model. Note this flag is provided at 1 Hz. See definition in table 2.3.3.1-3.

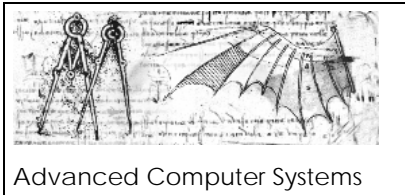

4 CRYOSAT LEVEL-2 PRODUCTS NAMING

It is assumed that the file names will follow the official conventions as for [MASTER-ICD].

MM_CCCC_XXXXXXXXXX_yyyymmdd_hhmmss_YYYYMMDD_HHMMSS__*bvvv*.ttt

MM = CS (Mission Identifier)

CCCC = file class which can be: OFFL (Off Line Processing/Systematic)

NRT_ (Near Real Time)

RPRO (ReProcessing)

TEST (Testing)

LTA_ (Long Term Archive)

yyymmdd_hhmmss = start time window as extracted from Job Order

YYYYMMDD_HHMMSS = stop time window as extracted from Job Order

b is the baseline identifier as read-in from the PCONF

vv is the version number of the file

ttt is the extension: HDR for Header and DBL for binary data

XXXXXXXXXX is the file type. For the Level 2 products, this is defined in the following table:

<i>File Type</i>	Description
SIR_LRM_2_	L2 Product from LRM Processing
SIR_FDM_2_	L2 Product from Fast Delivery Ocean Processing
SIR_SIN_2_	L2 Product from SARIN Processing
SIR_SID_2_	L2 Product from SARIN Degraded Processing
SIR_SAR_2A	L2 Product from SAR Step 1 Processing
SIR_SAR_2B	L2 Product from SAR Step 2 Processing
SIR_GDR_2A	L2 Consolidated Product in the first year of Mission
SIR_GDR_2B	L2 Consolidated Product in the second year of Mission
SIR_LRMI2_	Intermediate L2 Product from LRM Processing
SIR_FDMI2_	Intermediate L2 Product from Fast Delivery Ocean Processing
SIR_SINI2_	Intermediate L2 Product from SARIN Processing

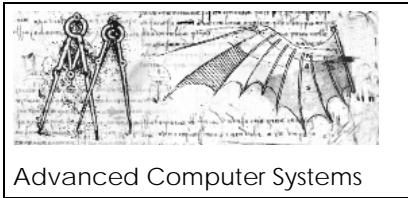

Instrument Processing Facility L2

Doc. No.: *CS-RS-ACS-GS-5123*
Issue: *2.1*
Date: *18 February 2008*
Page: *82*

SIR_SIDI2_	Intermediate L2 Product from SARIN Degraded Processing
SIR_SARI2A	Intermediate L2 Product from SAR Step 1 Processing
SIR_SARI2B	Intermediate L2 Product from SAR Step 2 Processing



Advanced Computer Systems



Instrument Processing Facility L2

Doc. No.: *CS-RS-ACS-GS-5123*
Issue: *2.1*
Date: *18 February 2008*
Page: *83*

END OF DOCUMENT